



*Manufacturers of Process  
Controls and Instrumentation*

# ***Instruction Manual***

Model: *MTS-XXX*

Function: *Modular Telemetry System*

- Module:
- XXX=8DI: 8-Channel Digital Input*
  - XXX=8DO: 8-Channel Digital Output*
  - XXX=4AI: 4-Channal Analog Input*
  - XXX=4AO: 4-Channel Analog Output*
  - XXX=PWR: Power Distribution*
  - XXX=RAD: Radio Communication*
  - XXX=4DIO: 4-Channel Digital Input & Output*

RF Band:  *902-928 MHz, 1W*

\_\_\_\_\_

Serial #: \_\_\_\_\_

*(If special or required)*

For Technical Assistance And Questions Call  
USA: (231) 788-2900 CANADA: (905) 660-5336

# WARNING

**THIS INSTRUCTION MANUAL MUST BE CAREFULLY READ BY ALL INDIVIDUALS WHO HAVE OR WILL HAVE THE RESPONSIBILITY FOR INSTALLING, USING OR SERVICING THIS PRODUCT. LIKE ANY PIECE OF COMPLEX EQUIPMENT, THIS PRODUCT WILL PERFORM AS DESIGNED ONLY IF INSTALLED, USED AND SERVICED IN ACCORDANCE WITH THE MANUFACTURER'S INSTRUCTIONS. OTHERWISE, IT COULD FAIL TO PERFORM AS DESIGNED AND PERSONS WHO RELY ON THIS PRODUCT FOR THEIR SAFETY COULD SUSTAIN SEVERE PERSONAL INJURY OR DEATH.**

The warranties made by Pribusin Inc. with respect to these products are voided if the products are not installed, used and serviced in accordance with the instructions in this instruction manual. Please protect yourself and others by following them.

## General Warnings and Cautions

- This apparatus is suitable for use in Class I, Division 2 Groups A, B, C & D
- **WARNING: EXPOSURE TO SOME CHEMICALS MAY DEGRADE THE SEALING PROPERTIES OF MATERIALS USED IN THE FOLLOWING DEVICES:**
  - Relay (MTS-8DO only): AROMAT (NAIS), JQ1-24V & JS1-24V (Inspect relays periodically to ensure that no degradation is found)
- **WARNING: EXPLOSION HAZARD. DO NOT REMOVE OR REPLACE LAMPS, FUSES OR PLUG-IN MODULES UNLESS POWER HAS BEEN DISCONNECTED OR THE AREA IS KNOWN TO BE FREE OF IGNITABLE CONCENTRATIONS OF FLAMMABLE GASES OR VAPORS.**
- **WARNING: EXPLOSION HAZARD. SUBSTITUTION OF COMPONENTS MAY IMPAIR SUITABILITY FOR CLASS I, DIVISION 2.**
- **WARNING: EXPLOSION HAZARD. DO NOT DISCONNECT WHILE CIRCUIT IS LIVE UNLESS AREA IS KNOWN TO BE NON-HAZARDOUS.**
- **AVERTISSEMENT: RISQUE D'EXPLOSION. NE PAS DEBRANCHER TANT QUE LE CIRCUIT EST SOUS TENSION, A MOINS QU'IL NE S'AGISSE D'UN EMPLACEMENT NON DANGEREUX.**
- **AVERTISSEMENT: RISQUE D'EXPLOSION. LA SUBSTITUTION DE COMPOSANTS PEUT RENDRE CE MATERIEL INACCEPTABLE POUR LES EMPLACEMENTS DE CLASSE 1, DIVISION 2.**

# MTS-RAD

## Module Dimensions:

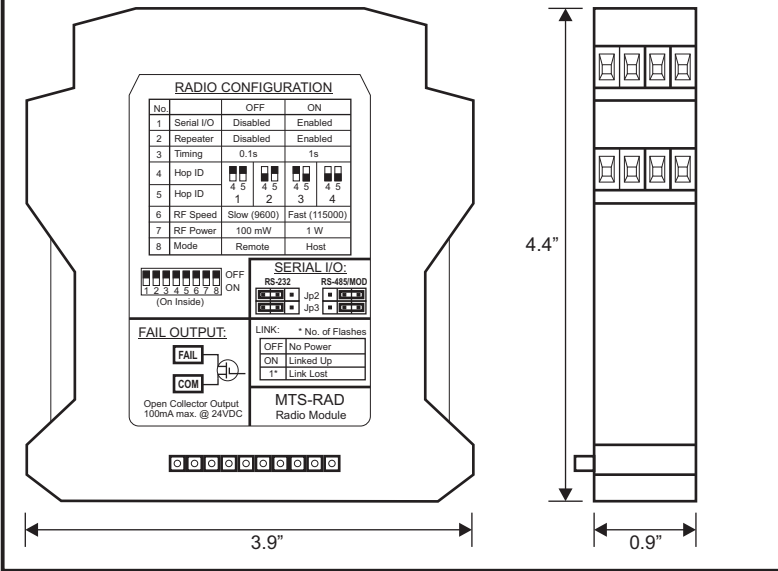

## Top View:

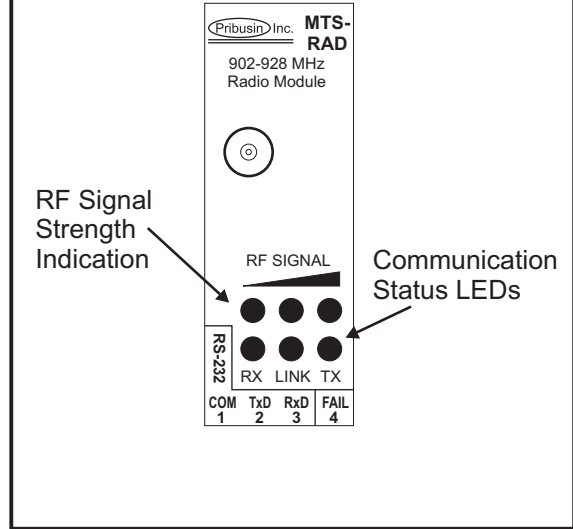

## System Example:

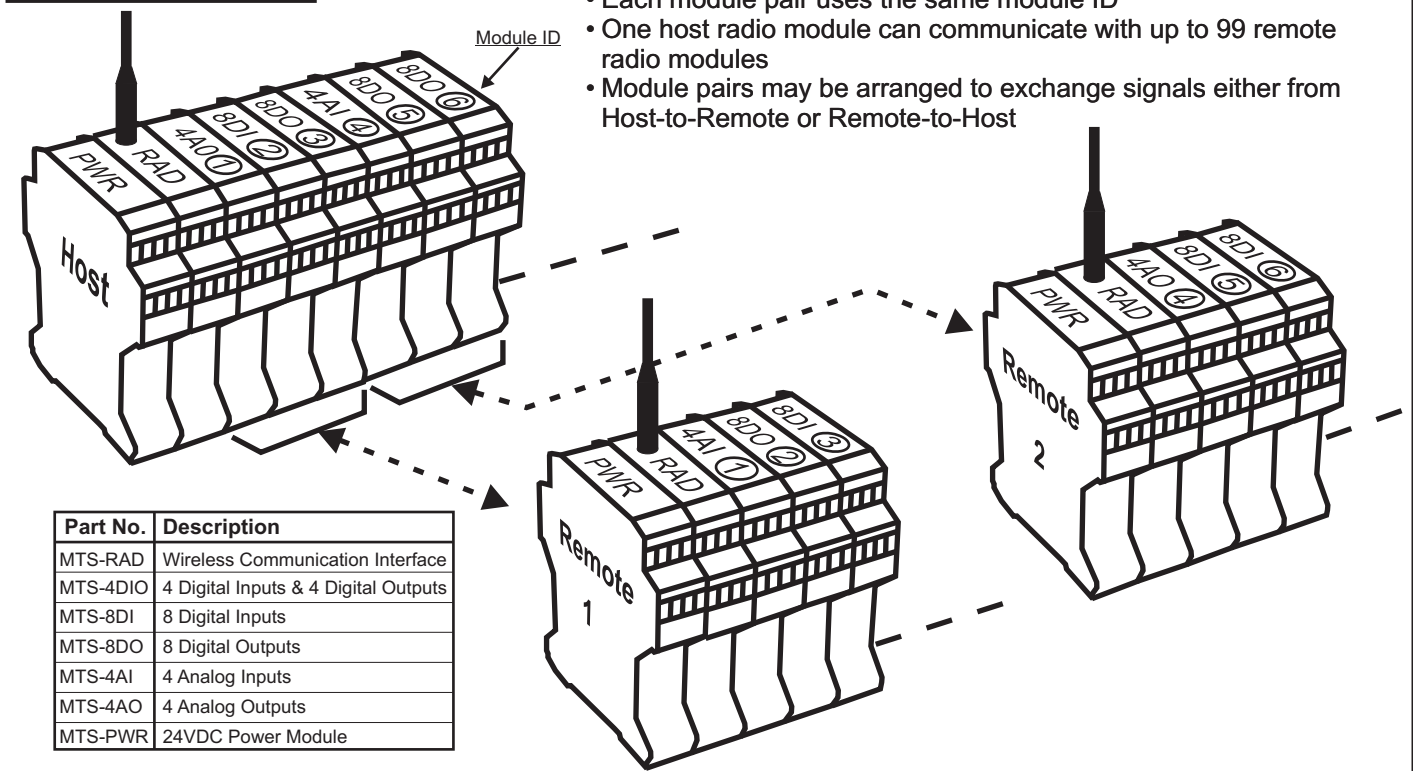

Part No.	Description
MTS-RAD	Wireless Communication Interface
MTS-4DIO	4 Digital Inputs & 4 Digital Outputs
MTS-8DI	8 Digital Inputs
MTS-8DO	8 Digital Outputs
MTS-4AI	4 Analog Inputs
MTS-4AO	4 Analog Outputs
MTS-PWR	24VDC Power Module

## Manufactured By:



www.pribusin.com  
info@pribusin.com

### USA:

Pribusin Inc.  
743 Marquette Ave.  
Muskegon, MI 49442  
Ph: (231) 788-2900  
Fx: (231) 788-2929



### CANADA:

Pribusin Inc.  
101 Freshway Dr. Unit 57  
Concord, Ontario, L4K 1R9  
Ph: (905) 660-5336  
Fx: (905) 660-4068

# MTS-RAD

## Module Dimensions:

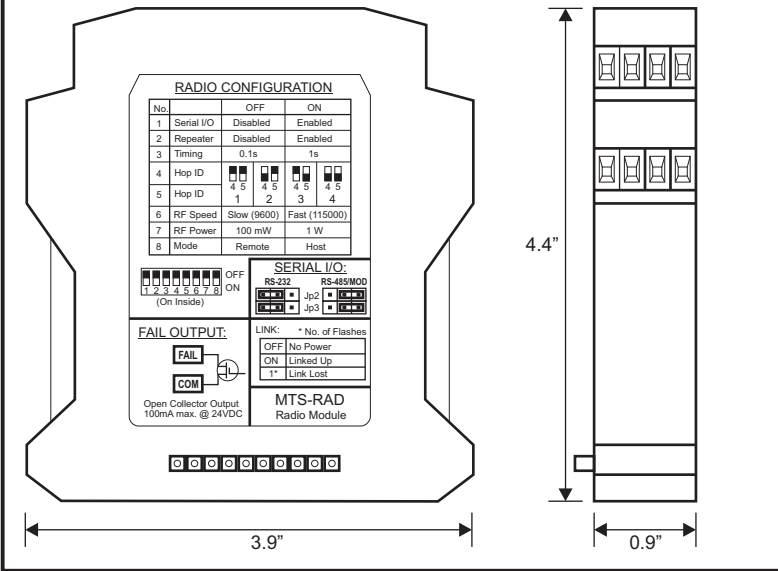

## Top View:

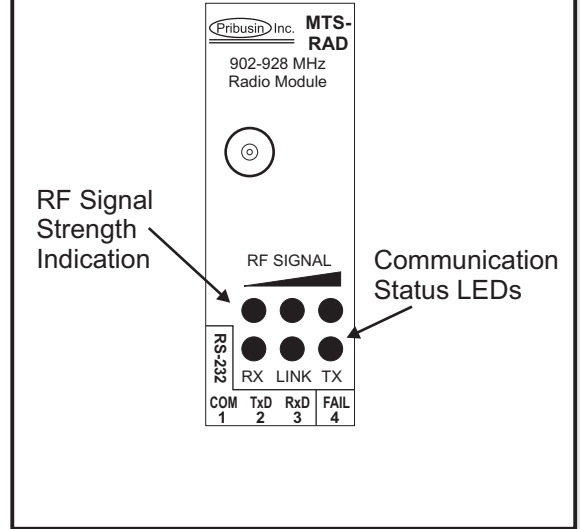

## System Example:

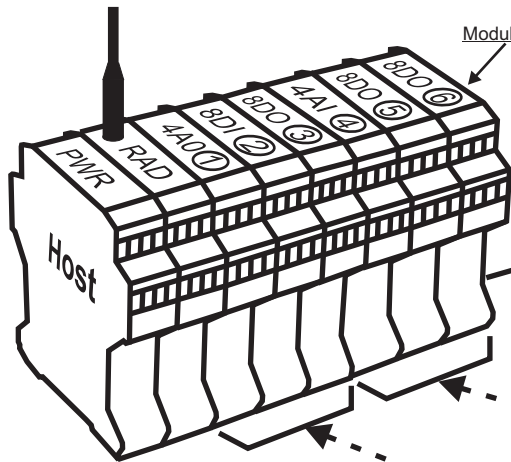

- Each Input module must have an Output module counterpart
- Each module pair uses the same module ID
- One host radio module can communicate with up to 99 remote radio modules
- Module pairs may be arranged to exchange signals either from Host-to-Remote or Remote-to-Host

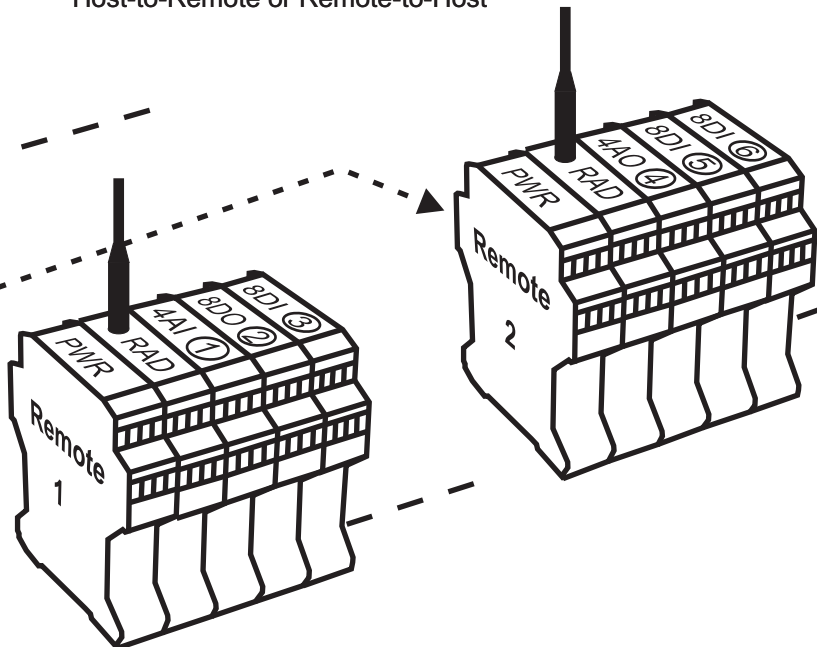

Part No.	Description
MTS-RAD	Wireless Communication Interface
MTS-4DIO	4 Digital Inputs & 4 Digital Outputs
MTS-8DI	8 Digital Inputs
MTS-8DO	8 Digital Outputs
MTS-4AI	4 Analog Inputs
MTS-4AO	4 Analog Outputs
MTS-PWR	24VDC Power Module

## Manufactured By:



www.pribusin.com  
info@pribusin.com

### USA:

Pribusin Inc.  
4319 E. Apple Ave.  
Muskegon, MI 49442  
Ph: (231) 788-2900  
Fx: (231) 788-2929



### CANADA:

Pribusin Inc.  
101 Freshway Dr. Unit 57  
Concord, Ontario, L4K 1R9  
Ph: (905) 660-5336  
Fx: (905) 660-4068

## **MTS-RAD Functional Description:**

The MTS-RAD is a wireless communications module that operates in the 902-928 MHz license-free ISM band. It serves as the communications link between two or more 'stacks' of MTS-XXX input and output modules.

Power and communication signal connections are achieved via the integral connector at the bottom of the module. Assembling a stack of several MTS modules on a DIN Rail and sliding them together is all that is required to interconnect I/O modules with the communications or power module.

### **Topology:**

There are two types of topologies that can be achieved with the MTS system: 1) Point-to-Point and 2) Point-to-Multi-Point. In a Point-to-Point system there is only one host stack and one remote stack. Each module on the host stack has a direct counterpart module on the remote stack. In a Point-to-Multi-Point system there is one host stack and two or more remote stacks. While the host stack holds one type of module, the counterparts to the host stack modules may be on any one of the remote stacks. The way that the modules link to one another is by their Module ID.

### **Hop Tables:**

The MTS radio uses spread-spectrum frequency-hopping radios that never occupy a single frequency channel for more than 250msec. To keep the radios synchronized, they use an internal frequency hop table to jump to subsequent channels in unison. Each radio can use one of four different hop tables. This allows several MTS systems to coexist in close proximity without interfering with one another.

### **RSSI Indication:**

The MTS-RAD has a 3 LED signal strength indicator that can be used to assess the quality of the RF signal that was received from another MTS-RAD. This indicator shows the received signal strength by the radio and thereby takes into account the receiving radios' antenna system as well as the transmitting radios' antenna system. In the case of poor signal strength both the receiving and sending systems must be carefully examined.

# MTS-RAD Installation:

## Physical Mounting:

The MTS-RAD module easily snaps onto standard 35mm top-hat style DIN rail for mounting. Each module has a 10-position interconnect bus near the base that provides power and inter-module communication. Once modules are snapped onto the DIN rail they simply slide together and connect via their integrated interconnect bus. See figure 1 below for an illustration.

To remove a module, slide it off the end of the DIN rail or insert a screwdriver into the slot of the retaining clamp at the base of the module and push the screwdriver towards the module – now lift it out.

**WHEN ASSEMBLING A STACK OF MODULES OR ADDING OR REMOVING A MODULE MAKE SURE POWER TO THE WHOLE STACK IS OFF.**

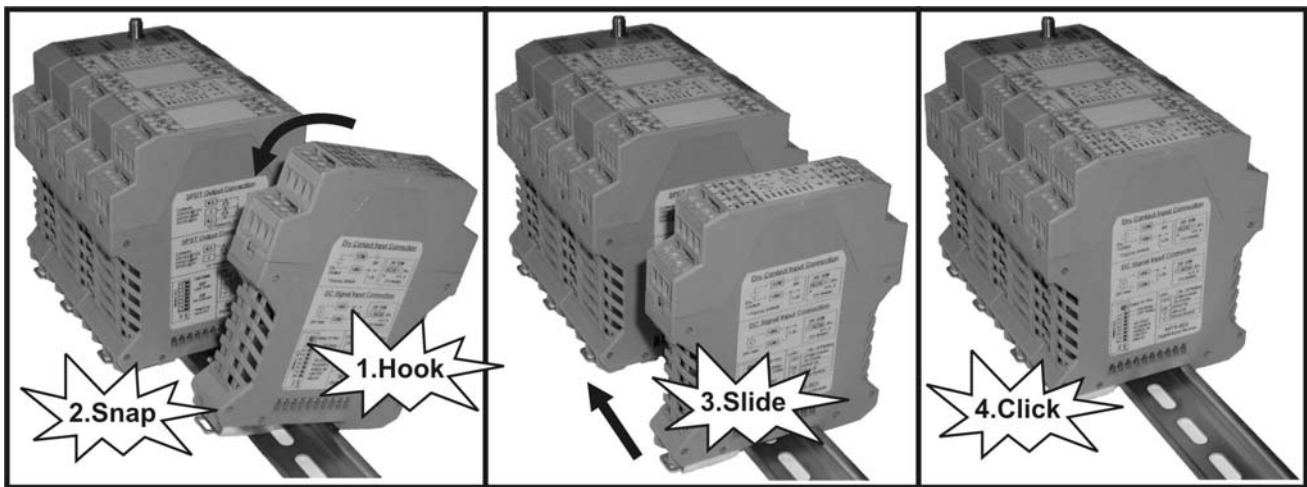

Figure 1

## Wiring:

To facilitate easy installation, all terminals are plug-in style and can be removed for wiring purposes. Figure 2 shows the arrangement of the RS232 serial link and the Fail output.

The RF connector on the MTS-RAD is an SMA Reverse Polarity bulkhead style connector (male). Only approved antennas may be connected to the MTS-RAD

**WARNING: MORE THAN ONE LIVE CIRCUIT – SEE DIAGRAM.**

**AVERTISSEMENT: PLUS QU'UN CIRCUIT SOUS TENSION – VOIR LE DIAGRAM**

**WARNING: EXPLOSION HAZARD. DO NOT DISCONNECT WHILE CIRCUIT IS LIVE OR UNLESS THE ARE IS KNOW TO BE FREE OF IGNITIBLE CONCENTRATIONS OF FLAMMABLE GASES OR VAPORS.**

**AVERTISSEMENT: RISQUE D'EXPLOSION. NE PAS DEBRANCHER TANT QUE LE CIRCUIT EST SOUS TENSION, A MOINS QU'IL NE S'AGISSE D'UN EMPLACEMENT NON DANGEREUX.**

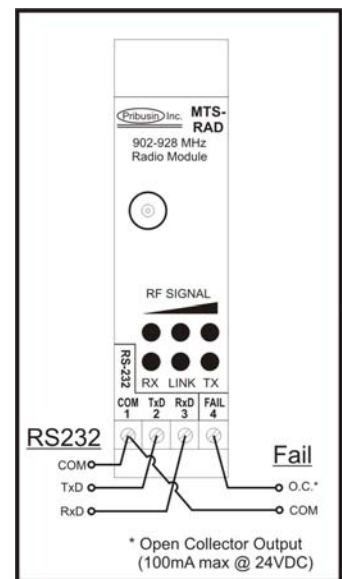

Figure 2

## MTS-RAD Configuration:

To configure some functions of the MTS-RAD it is necessary to remove the circuit board and cover assembly from the enclosure body. When doing so, make sure that you adequately protect yourself against static electricity buildup by wearing proper grounding straps.

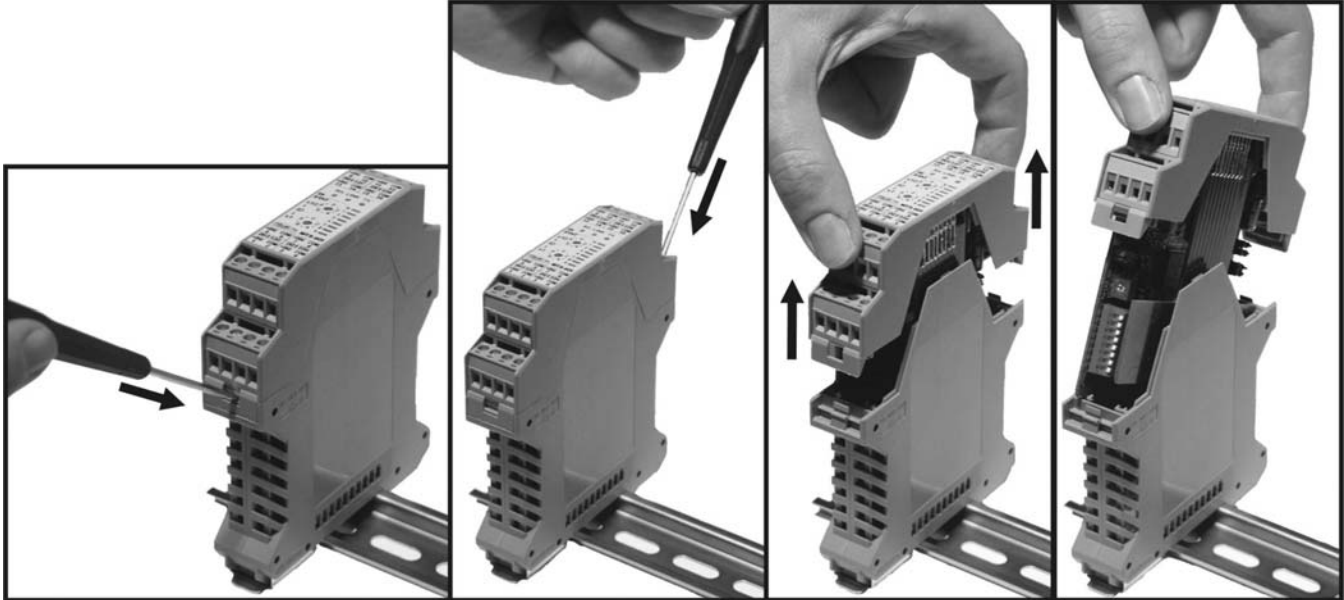

Figure 4

Figure 4 shows how to open the MTS enclosure. **Before proceeding, make sure all power is turned off to the MTS stack.** Using a small screwdriver, push in the two locking tabs on either side of the MTS just below the lower terminal plug. This unlocks the cover. Gently pull on the cover away from the enclosure body until the circuit board is free of the enclosure. Make the necessary adjustments and replace the cover and board assembly in the same orientation as it was removed. Be sure not to accidentally rotate the assembly by 180° when re-inserting it into the enclosure body. When inserting the lower end of the circuit board(s), make sure the board(s) slides into the guide-rails on the inside of the enclosure. Gently push on the top cover until it is firmly seated and the locking tabs click in place.

### Host or Remote Mode:

Each MTS system must have one stack designated as the Host Stack and all others designated as Remote Stacks. Whether a stack is a Host or Remote type is determined by the MTS-RAD module. If DIP switch 8 is ON then the MTS-RAD and all of its attached modules function as the Host Stack. If DIP switch 8 is OFF (default) then the MTS-RAD and all of its attached modules function as a Remote Stack.



Mode	SW1-8	
Remote	UP	
Host	DOWN	

Figure 5

### **RF Output Power:**

The MTS-RAD can be operated at one of two RF output power levels: 100mW or 1000mW (1Watt). DIP switch 7 is used to select the radio output power. If DIP Switch 7 is OFF (default) then RF output power is 100mW. If DIP Switch 7 is ON then RF output power is 1000mW (1W).



RF Output Power	SW1-7	
100 mW	UP	
1 W	DOWN	

Figure 6

**CAUTION:** FCC regulations stipulate a 36 dBm Effective isotropically-radiated power (EIRP) power requirement. Users implementing antenna gain greater than 6.0 dB must compensate for the added gain with cable loss. When operating at 1 W power output, the sum (in dB) of cable loss and antenna gain shall not exceed 6.0 dB.

### **EIRP Calculation:**

EIRP (dBm) = power of transmitter (dBm) – losses in transmission line (dB) + antenna gain (dB)

Where: power of transmitter = 30dBm @ 1W setting  
= 20 dBm @ 100mW setting

**CAUTION:** This equipment is approved only for mobile and base station transmitting devices. Antenna(s) used for this transmitter must be installed to provide a separation distance of at least 30 cm from all persons and must not be co-located or operating in conjunction with any other antenna or transmitter.

### **RF Baud Rate:**

The MTS-RAD can be operated at one of two RF transmission speeds: SLOW (9600 BAUD) or FAST (115,000 BAUD). DIP switch 6 is used to select the radio transmission speed. If DIP Switch 6 is OFF (default) then the RF speed is 9600 BAUD. If DIP Switch 6 is ON then the RF speed is 115000 BAUD.

RF BAUD Rate	SW1-6	
9600	UP	
115,000	DOWN	

Figure 7

Determining the best RF speed to use requires consideration of several factors:

- Slower RF speed increases transmission distance
- Faster RF speed reduces some types of interference

Only on-site testing will determine the best RF speed for any particular installation. Data throughput is affected only minimally by the RF speed because it is limited to 9600 BAUD.

**RF Hop Tables:**

The MTS-RAD uses one of four frequency hop tables. All MTS-RAD devices that are to communicate with one another must use the same hop table. Conversely, it is possible to have up to four different MTS systems operate within the same radio range by assigning each system to use a unique hop table.





Hop Table	SW1-4	SW1-5	
1	UP	UP	
2	DOWN	UP	
3	UP	DOWN	
4	DOWN	DOWN	

Figure 8

Figure 8

**Radio Repeater:**

The MTS-RAD (rev.F or higher) has the capability of acting as a radio repeater in addition to acting as a remote. By enabling the repeater function with SW1-2, all radio traffic received by this radio is re-transmitted automatically. This allows a remote unit that cannot directly communicate with a host to use the repeater to communicate with the host.

Repeater	SW1-2	
Disabled	UP	
Enabled	DOWN	

Figure 9

**CAUTION:** Only use repeaters if absolutely necessary and only enable the repeater function on the radios that must act as repeaters. Since each repeater re-transmits all radio traffic, there is a reduction in data throughput. The more repeaters there are in a system the more delay there will be.

**Serial Radio:**

The MTS-RAD can be used to interface with a serial device instead of with other MTS modules. A typical application of this would be a PLC acting as a host is connected to the MTS-RAD via RS-232. It uses MODBUS to communicate to various remote MTS systems. The serial mode of the MTS-RAD is controlled with SW1-1.



Serial I/O	SW1-1	
Disabled	UP	
Enabled	DOWN	

Figure 10

**NOTE:** Further configuration of the MTS-RAD may be necessary if using the serial function. Since this goes beyond the scope of this manual, please contact your local representative or Pribusin Inc. directly.

## MTS-RAD Operation:

When an MTS system is first powered on, there is a brief time of inactivity (approx. 30 seconds) while the MTS-RAD modules discover which I/O modules are present in their stack. After the discovery period is over, the modules on the Host Stack will begin communicating with their counter part modules on a Remote Stack. Communication occurs one module at a time and in numerical order for all Module ID's present on the Host Stack. A careful observer can witness this by the TX (transmit) and RX (receive) lights on each module.

## Link Status Light:

Once two MTS-RAD modules have communicated for the first time, they illuminate their Link lights to indicate that the modules have found each other and that a successful data exchange has taken place. This Link light will remain in a solid on state while communication between the two stacks continues to be successful.

The Link light will flash when there is a problem with the communication between the two modules. Several flashing sequences indicate the nature of the problem.

Link Status	Description
Off	Undiscovered or No Power
On	Linked with other Stack
1 Flash	Link with other Stack Lost

A **single flash** indicates that the module has lost communication with its counterpart module. Reasons for this include, but are not limited to:

Problem	Check
'Other Stack' lost Power	<ul style="list-style-type: none"><li>• Verify power on 'Other Stack'</li><li>• Check other Modules - Not likely if another Module from the 'Other Stack' is still communicating with a Module from 'This Stack'</li></ul>
Communication Module Bad on 'This Stack'	<ul style="list-style-type: none"><li>• Check other Modules on 'This Stack' – Not Likely if any are still linked and communicating</li></ul>

The above table describes some scenarios that could result in lost communication. For further assistance please contact your local representative or Pribusin Inc.

## Communication Fail Output:

In the event that the MTS-RAD loses communication it will indicate a communications link failure by the above mentioned Link Status Light and by activating its Fail Output. This output is an open-drain output capable of sinking 100mA at up to 24VDC. It can be used to signal to an operator or a PLC that there is a problem with the communication. The output will remain active while the communications link is lost. Once the link is re-established the output will de-activate. There is a 1 minute time delay from when the link is first lost until the output activates. This is to give the radios a chance to re-link in case the interruption was only temporary.

# MTS System Overview:

This section describes the concept and operation of a typical MTS system. The example below uses two remote sites, labeled 'Remote 1' and 'Remote 2'. Following are important points to note when designing or installing an MTS system:

- Every MTS system has one Host Stack and one or more Remote Stacks
- Each stack consists of at least one power module (MTS-PWR), one communications module (MTS-xxx, see table below for xxx), and one or more I/O modules
- I/O modules are always paired (one input module and one output module)
- One module of each pair (either input module or output module) MUST be on the Host Stack
- Each module pair MUST use the same Module ID
- Modules may be arranged to send their signals from Host-to-Remote or Remote-to-Host depending on which stack the input and output modules are located

Figure 11 shows a typical two remote system with a mixture of I/O modules arranged in ways so that some modules send signals from the Host Stack to the Remote Stacks while other modules send signals from a Remote Stack back to the Host Stack.

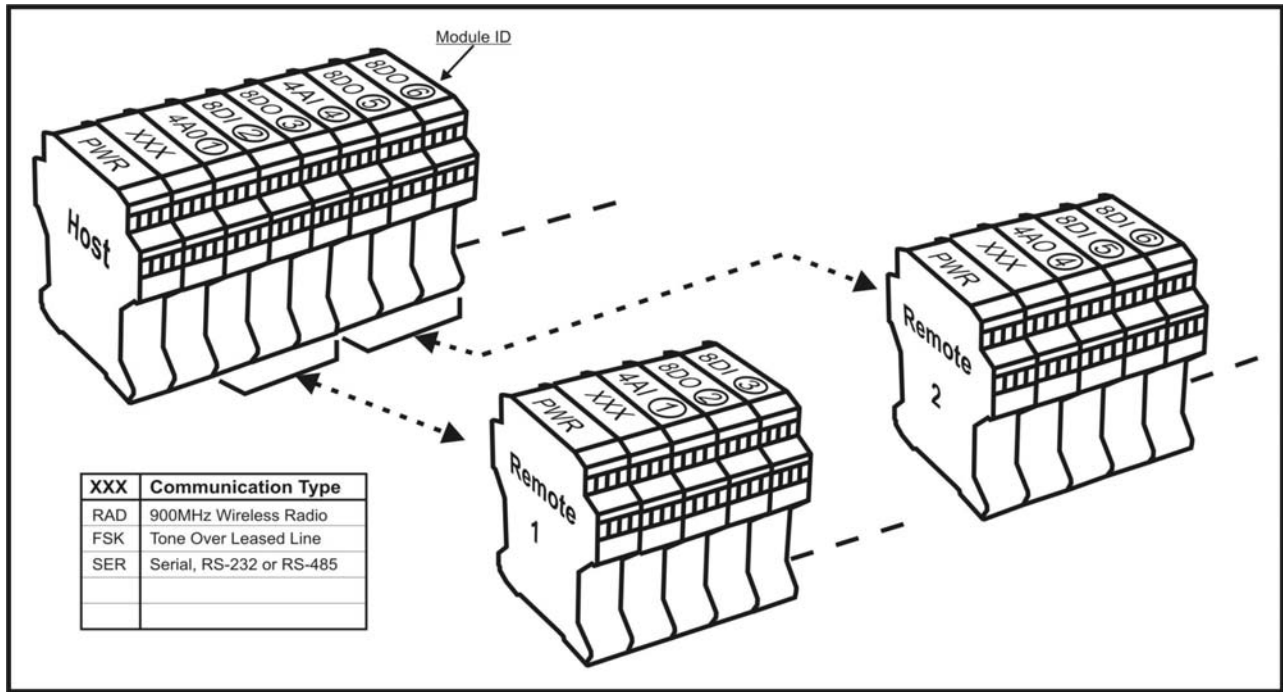

Figure 11

This table shows the modules that are currently available. Check our website at [www.pribusin.com](http://www.pribusin.com) or with your local representative for the latest list of available modules.

Model No.	Description
MTS-RAD	900MHz Wireless Comm. Module
MTS-8DI	8 Channel Digital Input Module
MTS-8DO	8 Channel Digital Output Module
MTS-4DIO	4 Channel Digital Input & Output Module
MTS-4AI	4 Channel Analog Input Module
MTS-4AO	4 Channel Analog Output Module
MTS-PWR	24VDC Power Module

## **Restocking Policy**

**All product returned to Pribusin Inc. in prime condition (not damaged, scratched or defaced in any way) within seven (7) months from the original date of shipment is subject to a 50% restocking charge. All product must be accompanied by a Return Authorization number (RA number) which must be obtained from Pribusin Inc. prior to returning any product.**

**After seven (7) months from the original date of shipment, products cannot be returned for restocking.**

**Custom designed products, modified products or all non-standard products may not be returned for restocking.**

## **Warranty Policy**

**Pribusin Inc. warrants equipment of its own manufacture to be free from defects in material and workmanship, under normal conditions of use and service, and will replace any component found to be defective, on its return to Pribusin Inc., transportation charges prepaid, within one year of its original purchase. Pribusin Inc. will extend the same warranty protection on equipment, peripherals and accessories which is extended to Pribusin Inc. by the original manufacturer. Pribusin Inc. also assumes noliability, expressed or implied, beyond its obligation to prelace any component involved. Such warranty is in lieu of all other warranties, expressed or implied.**