



*Manufacturers of Process
Controls and Instrumentation*

Instruction Manual

Model: *RCI-100-XXX*

Function: *Remote Control Signal Interface*

Communication: *XXX=SER: RS-232/485*
 XXX=MDM Modem Dial-Up
 XXX=FSK: Leased Line
 XXX=RFM: 2.4 Ghz Wireless

Input: 1 "Dry" Contact and 1 Analog Input

Output: 1 Form 'C' Contact and 1 Analog Output

Power: 117VAC, 50/60Hz
 24 VDC

Serial #: _____

(If special or required)

For Technical Assistance And Questions Call
USA: (231) 788-2900 CANADA: (905) 660-5336

Restocking Policy

All product returned to Pribusin Inc. in prime condition (not damaged, scratched or defaced in any way) within seven (7) months from the original date of shipment is subject to a 50% restocking charge. All product must be accompanied by a Return Authorization number (RA number) which must be obtained from Pribusin Inc. prior to returning any product.

After seven (7) months from the original date of shipment, products cannot be returned for restocking.

Custom designed products, modified products or all non-standard products may not be returned for restocking.

Warranty Policy

Pribusin Inc. warrants equipment of its own manufacture to be free from defects in material and workmanship, under normal conditions of use and service, and will replace any component found to be defective, on its return to Pribusin Inc., transportation charges prepaid, within one year of its original purchase. Pribusin Inc. will extend the same warranty protection on equipment, peripherals and accessories which is extended to Pribusin Inc. by the original manufacturer. Pribusin Inc. also assumes noliability, expressed or implied, beyond its obligation to prelace any component involved. Such warranty is in lieu of all other warranties, expressed or implied.

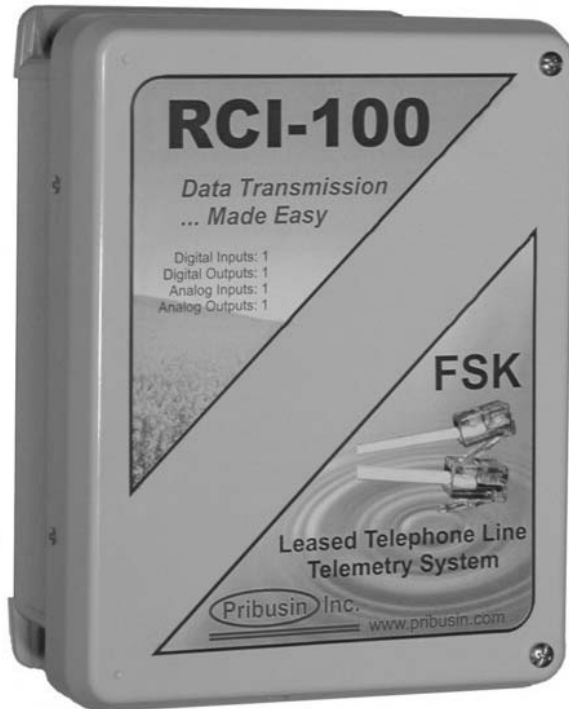

Standard Features:

- Bi-directional Communication using a Phone Line
- Uses MODBUS Protocol for Reliable Data Transfer
- 1 Dry Contact and 1 Analog Input
- 1 'C' Relay Contact and 1 Analog Output
- Uses Analog Half-Duplex Leased Telephone Line
- No Calibration Required
- Microprocessor Controlled for High Accuracy
- Power: 117 VAC 50/60 Hz (Optional 24 VDC)
- Built-in Overvoltage Protection on Telephone Line
- High Noise Rejection



Function:

The RCI-100-FSK is a bi-directional remote communication system that exchanges the status of 1 dry contact input and 1 analog input between a master and remote unit. Both the master and remote unit have inputs and outputs to allow remote monitoring and remote control.

Since the master and remote units are connected via leased telephone line, and hence are 'always-on', a change in signal at one end is transmitted to the other end with very little delay. This makes this unit ideal for real-time monitoring of remote tanks, pumps, etc.

The bi-directional operation allows for control signals to be sent back to the remote site to take action based on the incoming monitored signal.

This unit may also be used as a remote unit in a multi-remote system where the master is a multi-channel device such as the RCI-200, -400 or -800.

Connection:

Units are connected via a class 'C' line (Dial-up or leased). Regular J11 Phone Jacks make for easy installation. When connecting units on a PBX system make sure it can accept analog modem transmissions. Serial systems connect via standard modem cable.

Specifications:

- Transmission Medium: Analog Phone Line, Half-Duplex
- BAUD Rate: 2400 BAUD
- Transmission Output: -6dB max., -8dB typ.
- Operating Temperature: -20 Deg.C. to +50 Deg.C.
- Relay Contacts: 10A 1/8Hp @ 125VAC
6A 1/8Hp @ 277VAC
- Power: 117 VAC, 60/50 Hz
(24VDC Available)
- Enclosure: NEMA4X (NEMA12 available as an option)
- Approvals: ETL 3118354:
UL 60950-1-2007; CSA-C22.2 No. 60950-1-07

RCI-100-FSK

Enclosures & Dimensions:

Options: (Add letters to end of Model Number)

D - 8-Digit Scanning Display

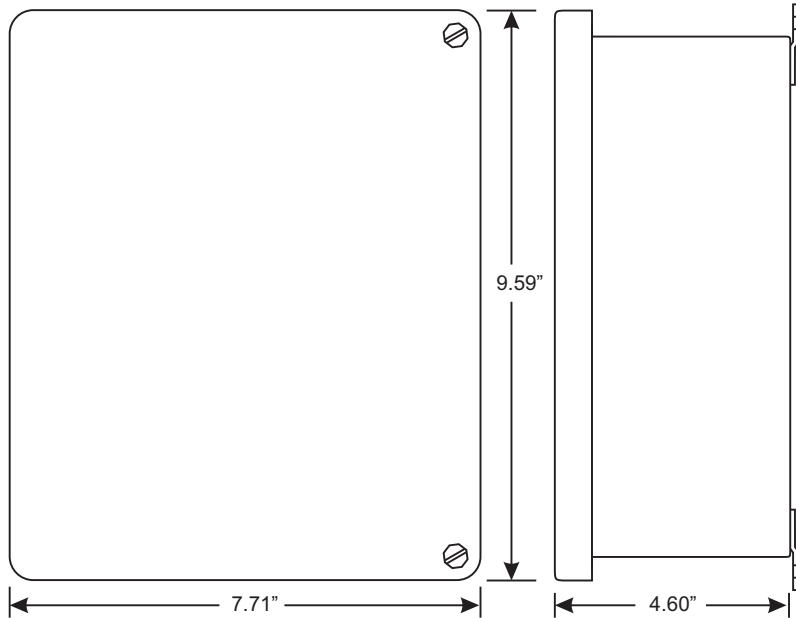

Connection:

1. Point-to-Point System: 2 RCI-100-FSK Units

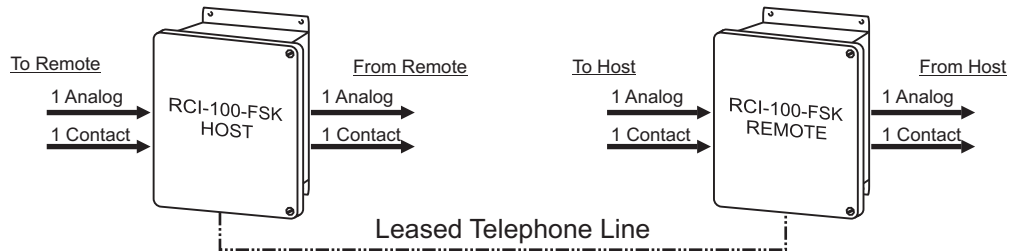

2. Host-to-Multi-Remote System:

- 1 RCI-200-FSK Host
- 2 RCI-100-FSK Remotes

This configuration provides **one** bi-directional analog and contact signal between one host unit and two remote units.

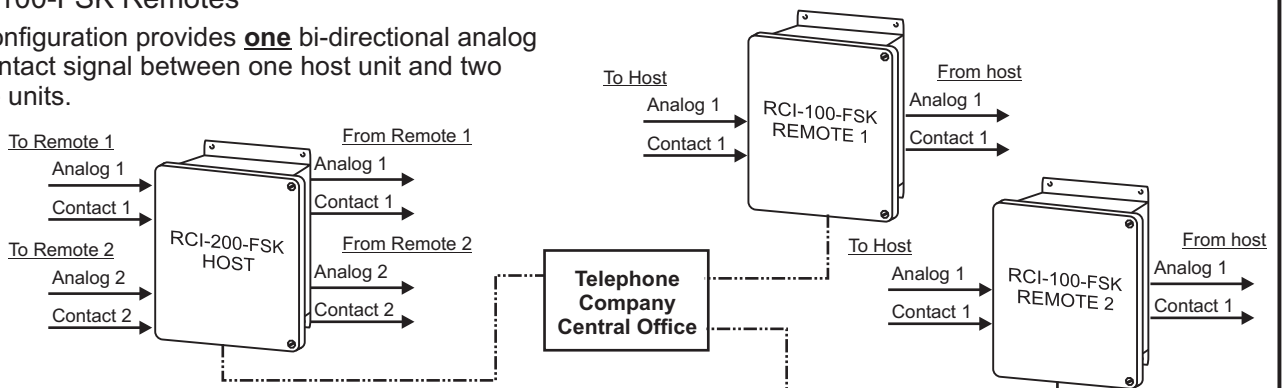

Manufactured By:

Pribusin Inc.

www.pribusin.com
info@pribusin.com

USA:

Pribusin Inc.
 743 Marquette Ave.
 Muskegon, MI 49442
 Ph: (231) 788-2900
 Fx: (231) 788-2929



CANADA:

Pribusin Inc.
 101 Freshway Dr. Unit 57
 Concord, Ontario, L4K 1R9
 Ph: (905) 660-5336
 Fx: (905) 660-4068

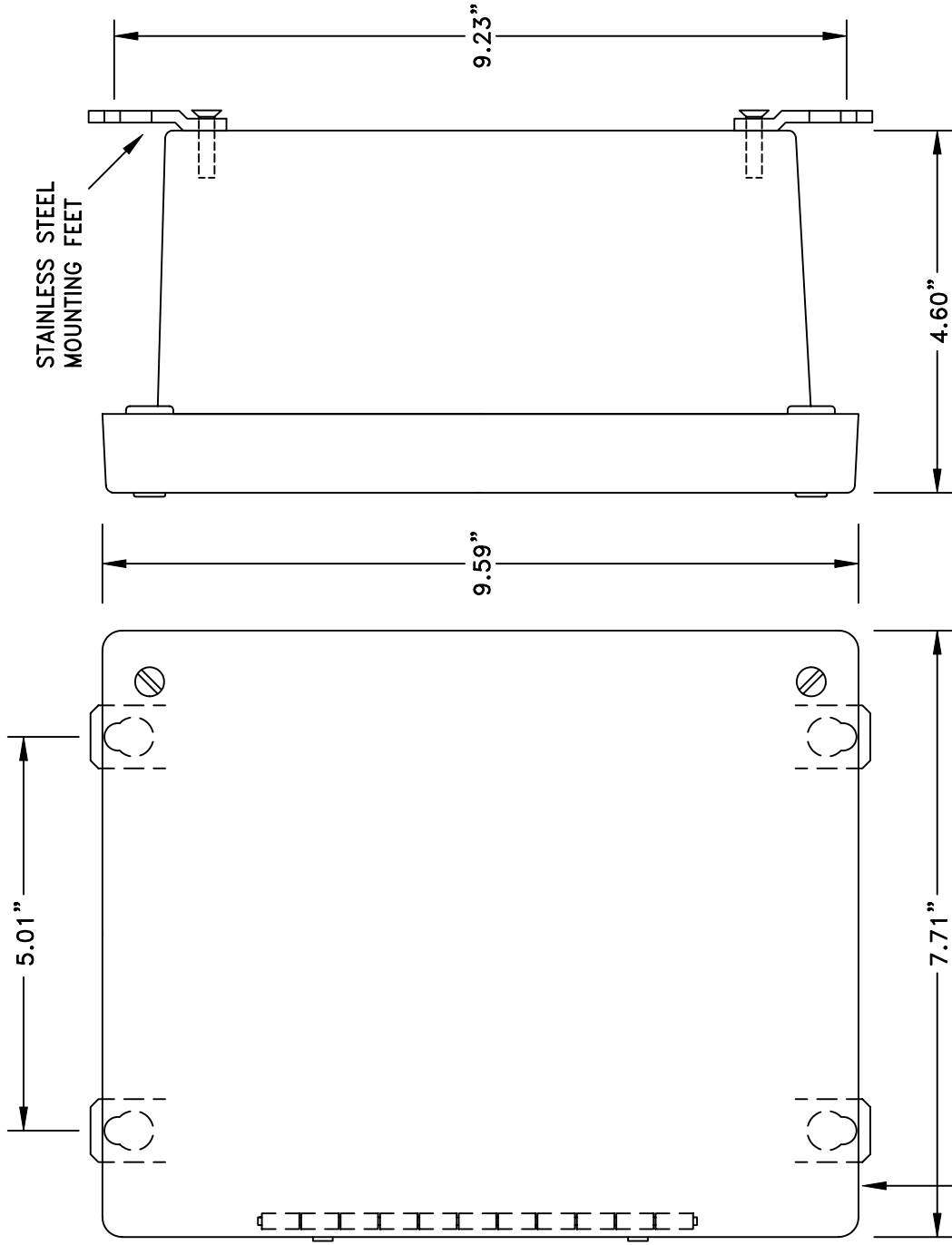

FRONT VIEW

SIDE VIEW

NEMA 4X AM SERIES FIBERGLASS ENCLOSURE
 WITH STAINLESS STEEL HINGE
 AND SCREW COVER

Pribusin Inc. ©			
CHKD:	DATE: OCT. 02/01	DRN: KS	
NEMA 4X AM SERIES FIBERGLASS ENCLOSURE (BOX SIZE: 8" x 6" x 4")			
DWG. NO.:	106470-2	REV. A	

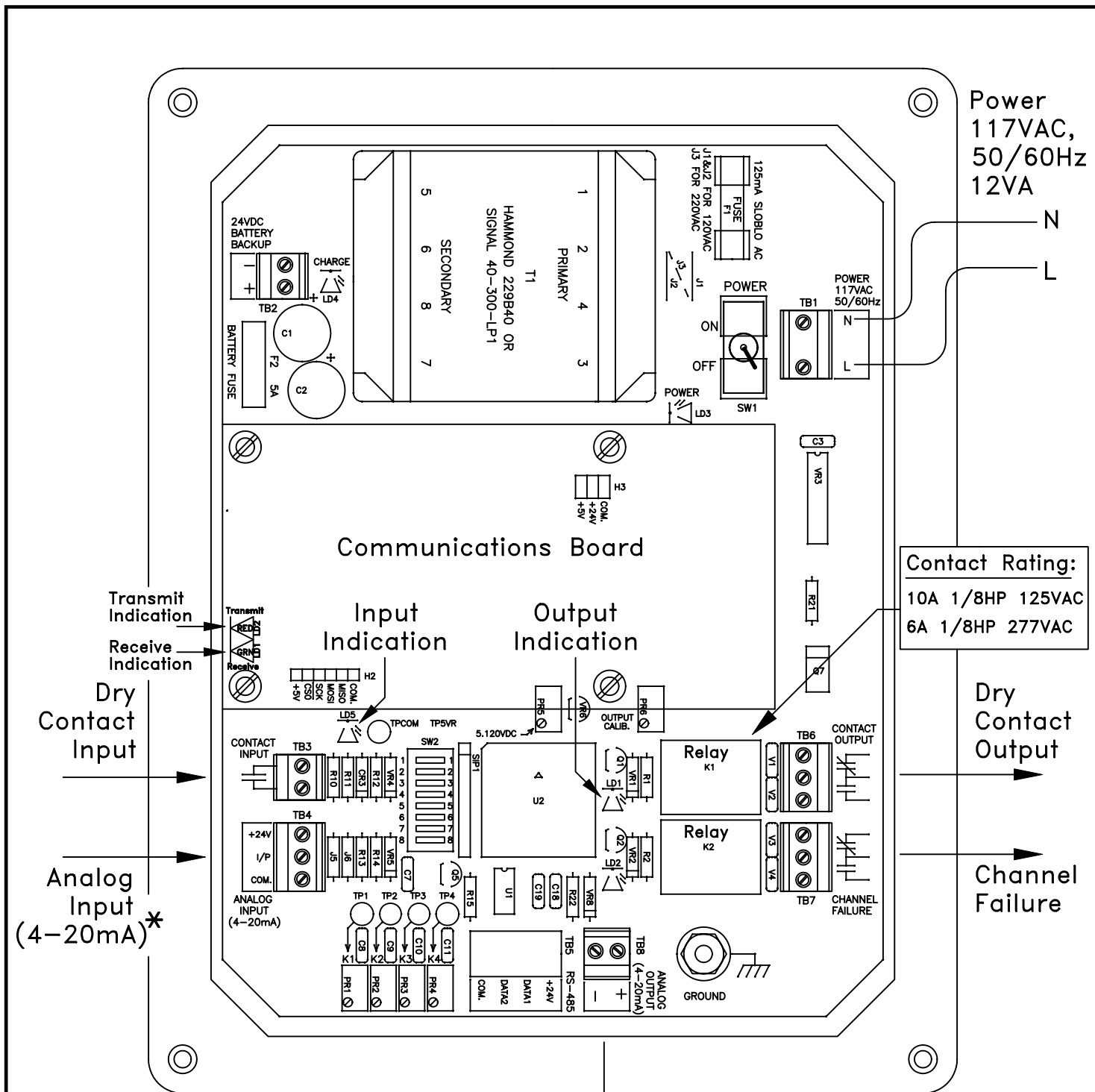

* 4-20 mA input and output ranges extend to 0 mA to 20 mA.

Analog Output (4-20mA)*

Pribusin Inc. ©		
CHKD:	DATE: Jan. 28/02	DRN: KS
Model: RCI-100-XXX Remote Control Signal Interface Panel Layout/Connections		
DWG. NO.:	106547	REV. A

Class C signal and control channel transmission characteristics

Type of Service :	Signal and control circuits by voice frequency tones/voice circuit alternate use of channel
Maximum information rate :	600 bauds
Mode of operation :	2 point or multipoint Half or full duplex (2 point only full duplex)
Method of termination :	2 wire or 4 wire
Impedance—source & load :	600 ohms, balanced & resistive
Impedance of channel :	Nominal 600 ohms
Maximum signal power :	-8 dbm composite tones (0 TLP)
Maximum voice level :	-8 Vu. (0 TLP) <i>Note: 0 TLP is zero level transmission reference point, generally sending station.</i>
Loss 1000 Hz :	20 db maximum (L)
Frequency Response	
350-2750 Hz :	-3 to +6 db referred to (L)
Outside this band :	Not specified—no DC transmission
Circuit background noise :	30 db signal-to-noise ratio minimum

Pribusin Inc. ©

CHKD : DATE : Apr. 17/97 DRN: KS

**Details on Class C
Telephone Line Transmission**

DWG. NO. : 105815 REV. A

RCI-100 Connections:

The RCI-100 is the main board of an RCI-100-XXX Telemetry system. It provides the input and output signal connections as well as the power supply for the unit. A separate communications board is added to the RCI-100 to allow it to communicate with other units. This communications board may have its own configuration that is in a separate section of this manual. The following configuration applies only to the RCI-100 board and is common to all communications interfaces.

AC Power & Fuse:

The RCI-100 is typically powered from 120VAC and protected by a 125mA SLOBLO fuse. It can be wired for 240VAC operation by removing (desoldering) power jumpers J1 & J2 and installing (soldering) jumper J3.

When changing the RCI-100 to 240VAC power make sure to change the fuse to half of its value, 62mA. This is important since at 240VAC the RCI-100 requires only half the current as if it were powered from 120VAC. Proper protection is only achieved by reducing the fuse value as mentioned above.

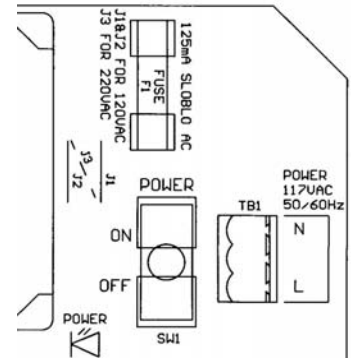

DC Power & Battery Backup:

The RCI-100 may also be powered from a 24VDC source which could be a battery or a DC power supply. The 24VDC power input is polarity protected with a fuse to prevent damage to the RCI-100 by inadvertent reverse polarity. A DC fuse provision is also provided if this power option is utilized. Insert a 5A automotive type blade fuse into the Battery Fuse socket.

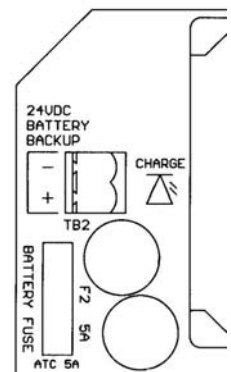

Inputs:

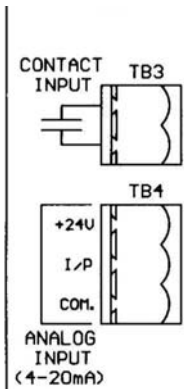

The RCI-100 has one dry contact input and one 0-20mA input. The dry contact input is excited with 24VDC and will source approximately 20mA when the contact is closed. A red LED lights up when the contact input is closed.

The analog input is configured as a 0-20mA input and has a 250 Ω input impedance. The input terminal has three connections: +24V, I/P, COM. The +24V power output may be used to power field transmitters. Up to 500mA may be used to power a transmitter. The input signal is connected to I/P(+) and COM(-).

The analog input is connected to the RCI-800 in two fashions: 1) Normal (3-wire connection) or 2) two-wire connection. On a 3-wire connected input, an external power supply or the +24V power output terminal of the RCI provides power to the field transmitter. The field transmitter has a current source that provides the 4-20mA signal back to the RCI-100. If using the power supply of the RCI-100, the field transmitter may draw up to 125mA.

On a 2-wire connected input, the field transmitter receives power from the RCI-100 and superimposes the signal onto the power return path. A maximum of 20mA will flow in such a connection. Make sure to consult the field transmitter manual to determine how to connect it to the RCI-100.

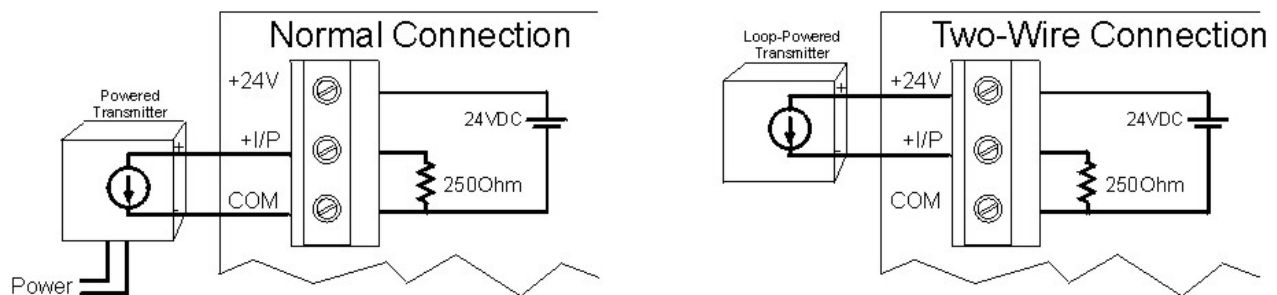

Outputs:

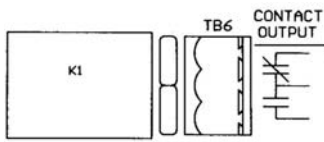

The RCI-100 has one form 'C' relay contact output and one 0-20mA analog output. The relay contact is capable of switching 120VAC, 10A or 240VAC, 6A. An energy absorbing varistor is installed across each contact to limit switching transients. A second relay contact acts as a communications fail indicator. If no communication occurred within 30 seconds, this relay contact will energize. Upon re-established communication this relay will de-energize again.

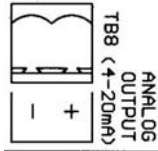

The analog output is typically configured as a 0-20mA output and can drive into a 1000Ω load, provided that the power supply to the unit is not below 24VDC. The output is not isolated from the input. Care must be taken when connecting the output to different devices so that no inadvertent ground loops are established.

Output Calibration & Input Testing:

The output on the RCI-100 is factory calibrated and should not require any adjustments. To check the calibration of the output and relays use switch SW2-7 & SW2-8 as shown below to set them to known states. If an output should require some adjustment, close SW2-8 only and turn the OUTPUT CALIB. trim pot until the output reads 20mA.

SW2-7	SW2-8	Function
OPEN	OPEN	Normal Operation
OPEN	CLOSED	Outputs=20mA, Relays=Energized
CLOSED	OPEN	Outputs=0mA, Relays=De-energized
CLOSED	CLOSED	Outputs=Inputs, Relays=Contact Inputs

If both switches are CLOSED, the analog and contact inputs are passed straight through to the analog and relay outputs. This may help in troubleshooting input and output signals.

Make sure both switches are OPEN before resuming normal operation.

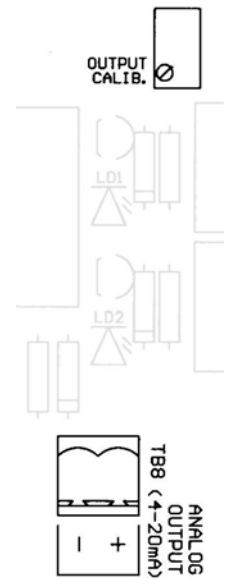

Battery Charger:

The RCI-100 has a battery connection that allows the system to remain powered up in the case of main power failure. The battery charger is designed to work with three (3) 6Volt lead-acid or gell-cell batteries. Switch SW2-6 to the CLOSED position to activate the battery charger. The charging LED will come on when the batteries are charging.

RCI-100 Configuration:

The RCI-100 requires no configuration other than for its communication fail operation. In the event of a communications failure on the communications board, the RCI-100 can be set up to take various actions on its outputs. This may be desirable in order to place connected devices into a safe operating mode. By default factory setting, all outputs remain at their last known state if a communications failure occurs.

SW2-	Function	OPEN	CLOSED
1	Relay Fail Mode	No Change	See SW2-2
2	Relay Fail Status	De-Energize	Energize
3	Output Fail Mode	No Change	Ramp to K1*
4			
5			
6	Battery Charger	Off	On
7	I/O Calibration		
8	I/O Calibration		

- * If SW2-3=CLOSED then the analog output will ramp to the setting of K1. The output will change at a rate determined by the setting of K2. The settings of the trim pots can be read on test points TP_{1,2} using a voltmeter. The test points read a voltage of 0-5V for a 0-100% adjustment.

$$TP_1 = \frac{Output}{20} \times 5Volt$$

$$TP_2 = \frac{RampRate}{60} \times 5Volt$$

where, *Output* = 0-20 (mA) and *Ramp Rate* = 0-60 (seconds) (5 sec. minimum)

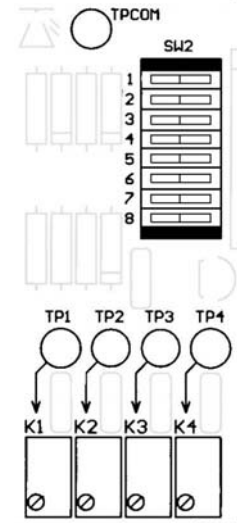

FSK Communication Option:

The -FSK communications option for the RCI series utilizes Frequency Shift Keying modems on a leased telephone line to exchange the signal data between a host and its remote(s). There are two types of **Topologies** that can be configured: 1) Point-to-Point and 2) Host-to-Multipoint.

In a **Point-to-Point** topology one host communicates with one remote. The two exchange all their signals with one another. The remote is configured as remote #1 even though it is the only remote in the system.

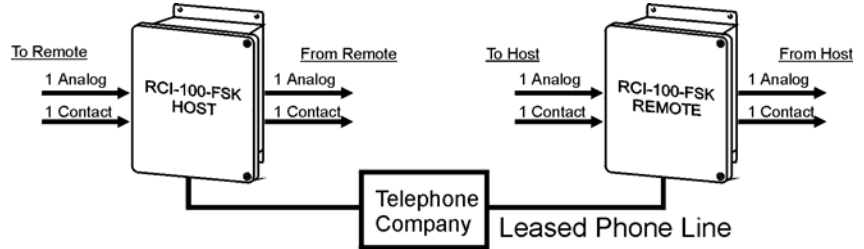

In a **Point-to-Multipoint** topology one host communicates to several remotes. Each remote is assigned an address (1,2,3, etc.) so that the host may distinguish between them. There may at most be as many remotes as there are inputs & outputs on the host.

For example, an RCI-200 system, having two analog/contact inputs and outputs, may communicate with up to two remotes each having one analog/contact input and output. In this case all **#1 inputs and outputs on the host correspond to the #1 inputs and outputs on remote #1** and all **#2 inputs and outputs on the host correspond to the #1 inputs and outputs on remote #2**.

There are two ways to physically connect a Host-to-Multipoint system:

1) Bridging the remotes' leased lines at the phone company resulting in one leased line being connected at the host (**preferred method**). This eliminates any impedance mismatch issues that may arise by connecting two or more phone lines in parallel.

2) Bridging the remotes' leased lines at the host. This can cause problems in some cases because of impedance mismatches in the two lines. It also attenuates the FSK signal, which means that a higher amplification setting on the FSK board is necessary. If there excess is noise on the lines this would now also be amplified and may interfere with the signal.

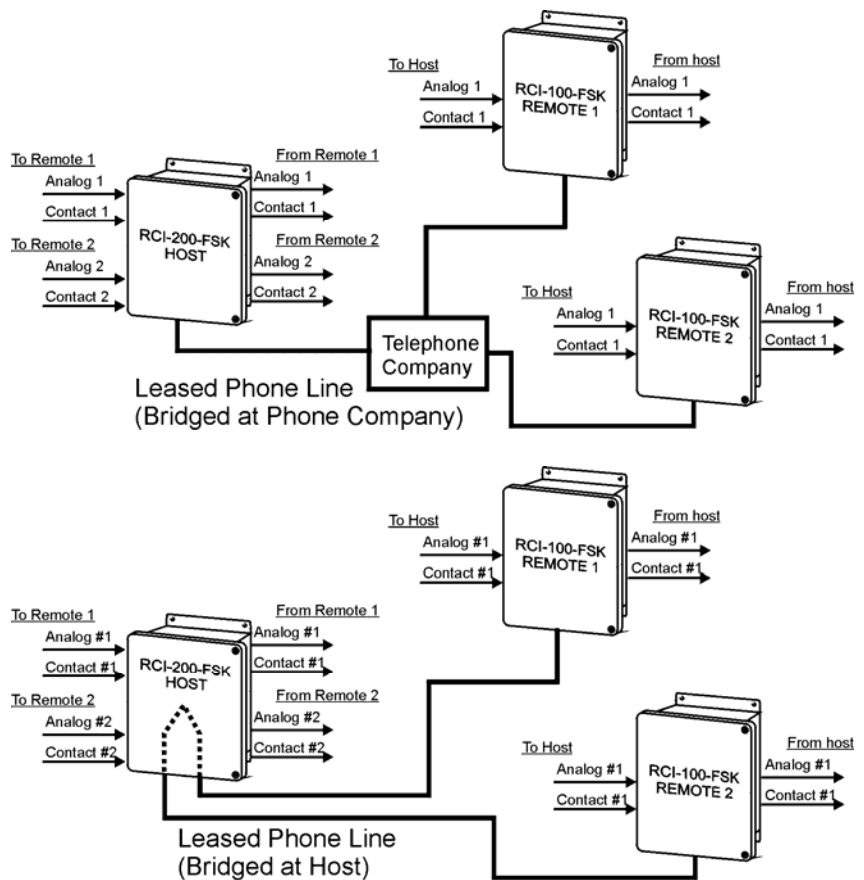

FSK Modem Configuration:

All FSK modem configurations are done via two banks of DIPswitches. SW1-1, -2, -3 assigns the remote address from 1 to 8 using a binary encoding scheme. SW2 assigns the Topology, Channel Numbers and Host/Remote Mode. The switches are located on the communications board just above the main circuit board. They are slide switches that slide **UP for ON** and **DOWN for OFF**.

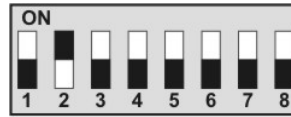

SW1-ADDRESS

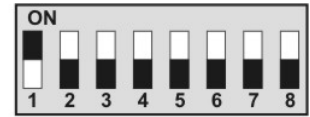

SW2- FUNCTION

The FSK communication board has two banks of 8-position DIPswitches: SW1 and SW2. The function of these switches is slightly different for a host unit and a remote unit.

SW1-	HOST	REMOTE
1	# of Remotes	Remote Address
2	# of Remotes	Remote Address
3	# of Remotes	Remote Address
4		
5		
6		
7		
8		

SW2-	HOST	REMOTE
1	# of Channels on each Remote	# of Channels on this Remote
2	# of Channels on each Remote	# of Channels on this Remote
3	# of Channels on Host	
4	# of Channels on Host	
5		
6		
7		
8	Host / Remote Select	Host / Remote Select

Host Configuration:

To make an RCI-100 operate as a host unit, make sure that SW2-8 is flipped down.



SW1-ADDRESS



SW2- FUNCTION

Next, set the **number of remotes** that the host is to communicate with using SW1-1, -2, -3. These switches are binary encoded as shown in the chart to the right.

SW1-1	SW1-2	SW1-3	# of Remotes
OFF	OFF	OFF	1



Next, set the **number of channels of each remote** using SW2-1, -2. One channel is considered 1 analog input/output plus 1 contact input/output. Hence an RCI-100 can have at most 1 channel.

SW2-1	SW2-2	Channels on Remotes
OFF	OFF	1



Next, set the **number of channels of the host** using SW2-3, -4. An RCI-100 can at most have 1 channel. This is the number of channels that will be exchanged between the host and each remote.

SW2-3	SW2-4	Channels on Host
OFF	OFF	1



Remote Configuration:

To make an RCI-100 operate as a REMOTE unit, make sure that SW2-8 is flipped up.

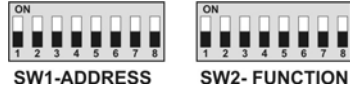

Next, set the **remote address** using SW1-1, -2, & -3. This switch is binary encoded and you will have to convert the remote address to binary first. The table to the right lists the beginning, most commonly used addresses.

SW1-1	SW1-2	SW1-3	Remote Address
OFF	OFF	OFF	1
ON	OFF	OFF	2
OFF	ON	OFF	3
ON	ON	OFF	4
OFF	OFF	ON	5
ON	OFF	ON	6
OFF	ON	ON	7
ON	ON	ON	8

1 Address	 SW1-ADDRESS	 SW2-FUNCTION	5 Address	 SW1-ADDRESS	 SW2-FUNCTION
2 Address	 SW1-ADDRESS	 SW2-FUNCTION	6 Address	 SW1-ADDRESS	 SW2-FUNCTION
3 Address	 SW1-ADDRESS	 SW2-FUNCTION	7 Address	 SW1-ADDRESS	 SW2-FUNCTION
4 Address	 SW1-ADDRESS	 SW2-FUNCTION	8 Address	 SW1-ADDRESS	 SW2-FUNCTION

Next, set the **number of channels on this remote** using SW2-1, -2. One channel is considered 1 analog input/output plus 1 contact input/output. Hence an RCI-100 can have at most 1 channel.

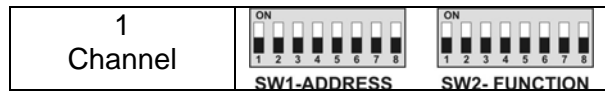

SW2-1	SW2-2	Channels on Remote
OFF	OFF	1

Receiver Gain Adjustment:

The FSK modem has a receive amplifier that can be used in various stages of amplification to enhance communication. If the phone line quality is poor or if the distance between units is great and presents a large signal loss, increasing the receiver gain can be used to amplify the incoming signal to restore reliable communication. Three gain settings are available: +10dB, +20dB and +30dB. These are selected via switch SW3. If all three switches are off, there is no amplification.

Use the lowest amplification setting that yields good results since too high of an amplification setting can distort the signal yielding unreliable communication also. To judge the state of your communication, use the RED and GREEN Transmit and Receive LEDs.

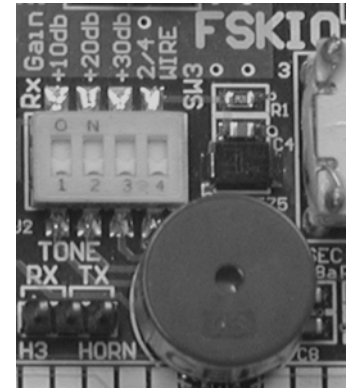

Transmit, Receive & Link Indicators:

The RCI FSK modem board has four indicators (LEDs) near the left edge that indicate *Power* “+5V” (RED), *Link* (YELLOW), *Transmit* “TX” (RED) and *Receive* “RX” (GREEN). On a host unit, the RED Transmit LED will light first for a fraction of a second. This is an interrogation message sent to one of the remotes. If the remote received the message entirely and correctly, it will reply with a return message, which causes the host’s GREEN Receive LED to light for a fraction of a second. This is followed by the host then sending out the next message and so on.

In other words, every Transmit LED flash should be followed by a Receive LED flash. If a Transmit LED flash is NOT followed by a Receive LED flash this means that one of the remotes did not receive its interrogation message properly or is currently not powered or there is a problem with the leased telephone line. By changing the receiver gain setting try to achieve a continuous Transmit/Receive LED flash pattern.

Occasional transmission misses are of no real concern since the units wait for 1 minute during a continuous communication loss before signaling a loss of communication. During this 1-minute delay all outputs are held at their last known value.

On a remote unit, the order of the LED flashes is reversed since the remote waits for an interrogation message from the host before it replies. The Receive LED will flash first followed by a flash of the Transmit LED.

A complete data exchange requires 4 transmissions between the host and a remote. This becomes important when considering a Host-to-Multipoint system. On the host the LED flash sequence remains unchanged. On the remote units, however, the Receive LED will flash every time any message is sent on the phone line. This includes messages not intended for a given remote. For example, if the host is currently communicating with remote #1, the Receive LED on remote #2 will flash for every interrogation and reply message that are exchanged between the host and remote #1. Only when the host begins to communicate with remote #2 does the normal Receive/Transmit flash sequence occur.

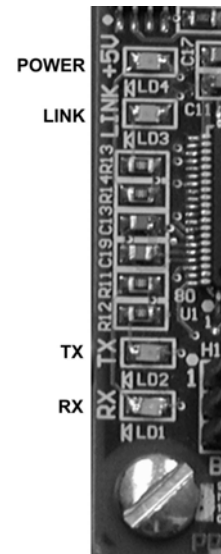

Leased Line Connection & Specifications:

The RCI-XXX-FSK uses a leased line to communicate. A leased line is a regular telephone line without the dial tone. It is essentially always ON. If you were to connect a telephone at either end and both people were to pick up the receiver they could just start talking.

The leased line must be specially installed by the telephone company and they may have various services available. The RCI-XXX-FSK does not require a special type of service (such as data, full-duplex, etc.). All that is required is a 2-wire or 4-wire, un-powered, voice-grade line without dial tone.

2-Wire vs. 4-Wire Phone Line Connection:

The RCI-XXX-FSK can operate on either a 2-wire or a 4-wire leased phone line. SW3-4 selects the type of leased phone line that is connected to the RCI-XXX-FSK. All units of one system must use the same type of connection (either 2-wire or 4-wire). Four fuses are provided for protection of the FSK modem. They are a 1/4A fast-blo 5x20mm type.

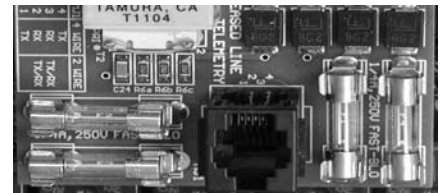

We strongly suggest installing additional surge and lightning protection at the point where the leased line enters the building. The protection on the FSK modem board is not sufficient to protect against lightning strikes or large power surges.

On a **2-wire leased phone line** (SW3-4 ON), data is transmitted and received over a single pair of wires using the inner two pins of the RJ-11 phone jack (pins 2 & 3). On a standard phone cable these wires are red and green and they are connected the same way on all units. Polarity does not matter and red and green wires may be interchanged.

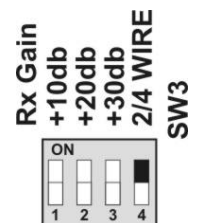
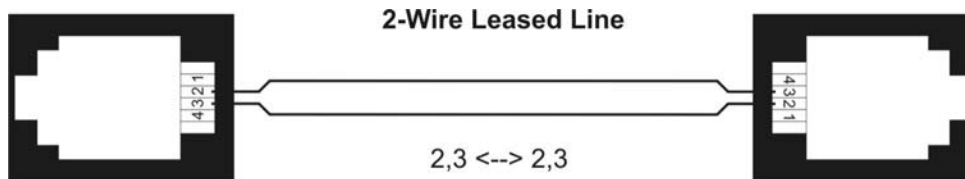

On a **4-wire leased phone line** data is transmitted on the outer two pins of the RJ-11 phone jack (pins 1 & 4) and received on the inner two pins of the RJ-11 phone jack (pins 2 & 3). On a standard phone cable the outer two wires are black and yellow while the inner two wires are red and green. It is important that the transmit pair (pins 1 & 4) from one unit is connected to the receive pair (pins 2 & 3) on the other units and vice versa.

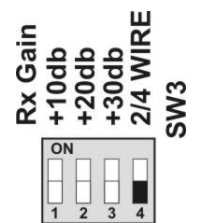
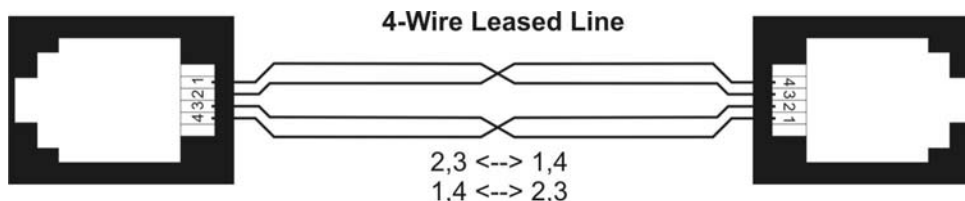

Point-to-Point Communication

Communication between one host and one remote is called point-to-point.

Example 1: An RCI-100 Host communicating with an RCI-100 Remote



SW1-ADDRESS



SW2- FUNCTION

RCI-100 (Host)

Host Channels: 1
Number of Remotes: 1
Channels on Remotes: 1



SW1-ADDRESS



SW2- FUNCTION

RCI-100 (Remote)

Remote Channels: 1
Address: 1

Example 2: An RCI-200 Host communicating with an RCI-200 Remote



SW1-ADDRESS



SW2- FUNCTION

RCI-200 (Host)

Host Channels: 2
Number of Remotes: 1
Channels on Remotes: 2



SW1-ADDRESS



SW2- FUNCTION

RCI-200 (Remote)

Remote Channels: 2
Address: 1

Example 3: An RCI-400 Host communicating with an RCI-400 Remote



SW1-ADDRESS



SW2- FUNCTION

RCI-400 (Host)

Host Channels: 4
Number of Remotes: 1
Channels on Remotes: 4



SW1-ADDRESS



SW2- FUNCTION

RCI-400 (Remote)

Remote Channels: 4
Address: 1

Example 4: An RCI-800 Host communicating with an RCI-800 Remote



SW1-ADDRESS



SW2- FUNCTION

RCI-800 (Host)

Host Channels: 8
Number of Remotes: 1
Channels on Remotes: 8



SW1-ADDRESS



SW2- FUNCTION

RCI-800 (Remote)

Remote Channels: 8
Address: 1

Point-to-Multipoint Communication

Communication between a host and more than one remote is called point-to-multipoint.

Example 1: An RCI-200 Host communicating with (2) RCI-100 Remotes



SW1-ADDRESS



SW2- FUNCTION



SW1-ADDRESS



SW2- FUNCTION



SW1-ADDRESS



SW2- FUNCTION

RCI-200 (Host)

Host Channels: **2**
 Number of Remotes: **2**
 Channels on Remotes: **1**

RCI-100 (Remote 1)

Remote Channels: **1**
 Address: **1**

RCI-100 (Remote 2)

Remote Channels: **1**
 Address: **2**

Example 2: An RCI-400 Host communicating with (2) RCI-200 Remotes



SW1-ADDRESS



SW2- FUNCTION



SW1-ADDRESS



SW2- FUNCTION



SW1-ADDRESS



SW2- FUNCTION

RCI-400 (Host)

Host Channels: **4**
 Number of Remotes: **2**
 Channels on Remotes: **2**

RCI-200 (Remote 1)

Remote Channels: **2**
 Address: **1**

RCI-200 (Remote 2)

Remote Channels: **2**
 Address: **2**

Example 3: An RCI-800 Host communicating with (2) RCI-400 Remotes



SW1-ADDRESS



SW2- FUNCTION



SW1-ADDRESS



SW2- FUNCTION



SW1-ADDRESS



SW2- FUNCTION

RCI-800 (Host)

Host Channels: **8**
 Number of Remotes: **2**
 Channels on Remotes: **4**

RCI-400 (Remote 1)

Remote Channels: **4**
 Address: **1**

RCI-400 (Remote 2)

Remote Channels: **4**
 Address: **2**

Example 4: An RCI-800 Host communicating with (3) RCI-200 Remotes



RCI-800 (Host)

Host Channels: **8**
Number of Remotes: **3**
Channels on Remotes: **2**



RCI-200 (Remote 1)

Remote Channels: **2**
Address: **1**

RCI-200 (Remote 2)

Remote Channels: **2**
Address: **2**

RCI-200 (Remote 3)

Remote Channels: **2**
Address: **3**