



*Manufacturers of Process
Controls and Instrumentation*

Instruction Manual

Model: *RCI-100-XXX*

Function: *Remote Control Signal Interface*

- Communication: *XXX=SER: RS-232/485*
 XXX=MDM Modem Dial-Up
 XXX=FSK: Leased Line
 XXX=RF9: 900 Mhz Wireless
 XXX=RF2: 2.4 Ghz Wireless

Input: 1 "Dry" Contact and 1 Analog Input

Output: 1 Form 'C' Contact and 1 Analog Output

- Power: 117VAC, 50/60Hz
 24 VDC

Serial #: _____

(If special or required)

For Technical Assistance And Questions Call
USA: (231) 788-2900 CANADA: (905) 660-5336

Restocking Policy

All product returned to Pribusin Inc. in prime condition (not damaged, scratched or defaced in any way) within seven (7) months from the original date of shipment is subject to a 50% restocking charge. All product must be accompanied by a Return Authorization number (RA number) which must be obtained from Pribusin Inc. prior to returning any product.

After seven (7) months from the original date of shipment, products cannot be returned for restocking.

Custom designed products, modified products or all non-standard products may not be returned for restocking.

Warranty Policy

Pribusin Inc. warrants equipment of its own manufacture to be free from defects in material and workmanship, under normal conditions of use and service, and will replace any component found to be defective, on its return to Pribusin Inc., transportation charges prepaid, within one year of its original purchase. Pribusin Inc. will extend the same warranty protection on equipment, peripherals and accessories which is extended to Pribusin Inc. by the original manufacturer. Pribusin Inc. also assumes noliability, expressed or implied, beyond its obligation to prelace any component involved. Such warranty is in lieu of all other warranties, expressed or implied.



Standard Features:

Bi-directional Communication using License-free 900MHz Radio Band

Spread-Spectrum Radio Technology Provides Reliable Communication

Re-Transmission & Error Correction Algorithms ensure Accurate Data Transmission

1 Dry Contact and 1 Analog Input

1 'C' Relay Contact and 1 Analog Output

Point-to-Point or Host-to-Multipoint Topologies

No Calibration Required

Microprocessor Controlled for High Accuracy

Power: 117 VAC 50/60 Hz (Optional 24 VDC)

High Noise Rejection

Function:

The RCI-100-RF9 is a bi-directional data communication system that exchanges the status of 1 dry contact input and 1 analog input between a master and one or more remote units. A basic system consists of one master station and one remote station each with 1 dry contact and 1 analog inputs and 1 'C' relay contact and 1 analog output. All signals are bi-directional so that data may be read from the remote station and sent to it.

The license-free spread-spectrum radio technology allows small systems to be set up with very little effort and at low cost. The technology ensures high communication reliability even in RF-intensive environments.

All units are sold without antennas. Pribusin carries a complete assortment of antennas and accessories.

Options:

- A: 24VDC Power

- B: 240VAC Power

- N12: NEMA 12 Enclosure

Specifications:

Media: 900MHz Spread-Spectrum Radio

Range: up to 1500ft indoors with omnidirectional antenna
up to 12 miles line-of-sight with directional antenna

Protocol: MODBUS ASCII, 9600 BAUD

RF Connector: N-Female (Bottom of Enclosure)

Radio Power Output: 100mW, 1W (selectable)

Operating Temperature: -4°F to +140°F (-20°C to +60°C)

Relay Contacts: 10A 1/8Hp @ 125VAC

6A 1/8Hp @ 277VAC

Power: 117 VAC, 60/50 Hz, 24VDC Available

Enclosure: NEMA4X (NEMA12 available as an option)

RCI-100-RF9

Enclosures & Dimensions:

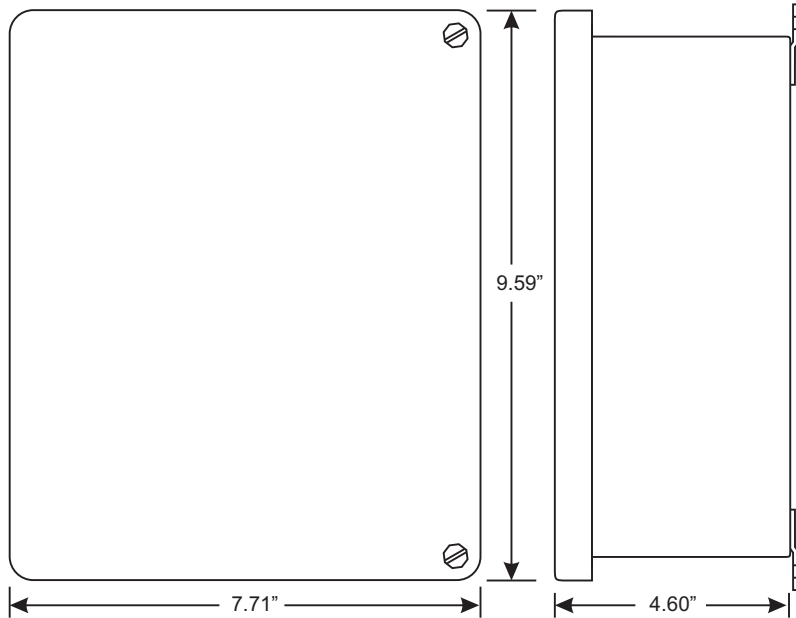

Connection:

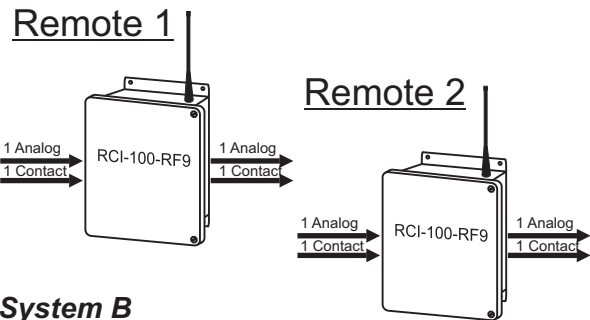
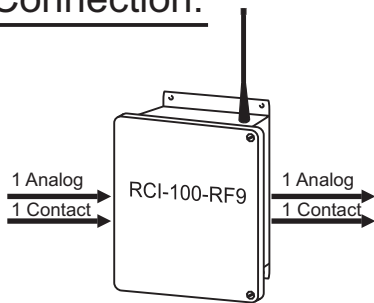

System B Master to Multi-Remote

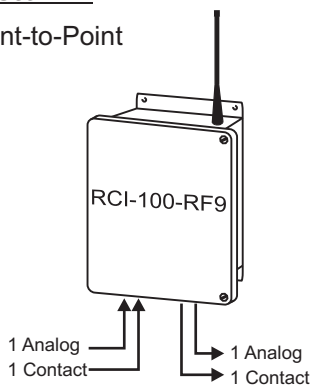

Master

OR

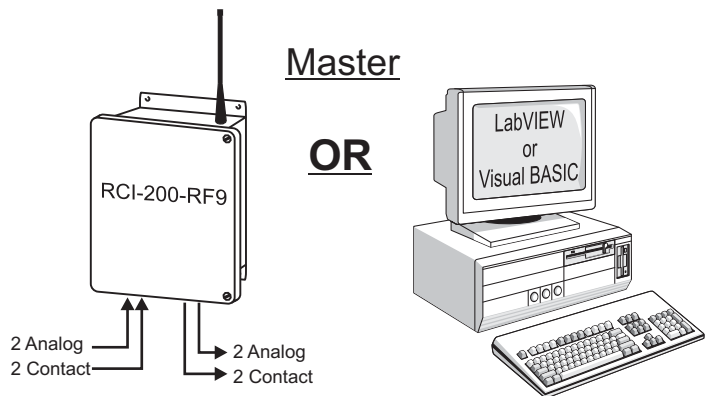

Manufactured By:

Pribusin Inc.

www.pribusin.com
info@pribusin.com

USA:

Pribusin Inc.
743 Marquette Ave.
Muskegon, MI 49442
Ph: (231) 788-2900
Fx: (231) 788-2929



CANADA:

Pribusin Inc.
101 Freshway Dr. Unit 57
Concord, Ontario, L4K 1R9
Ph: (905) 660-5336
Fx: (905) 660-4068

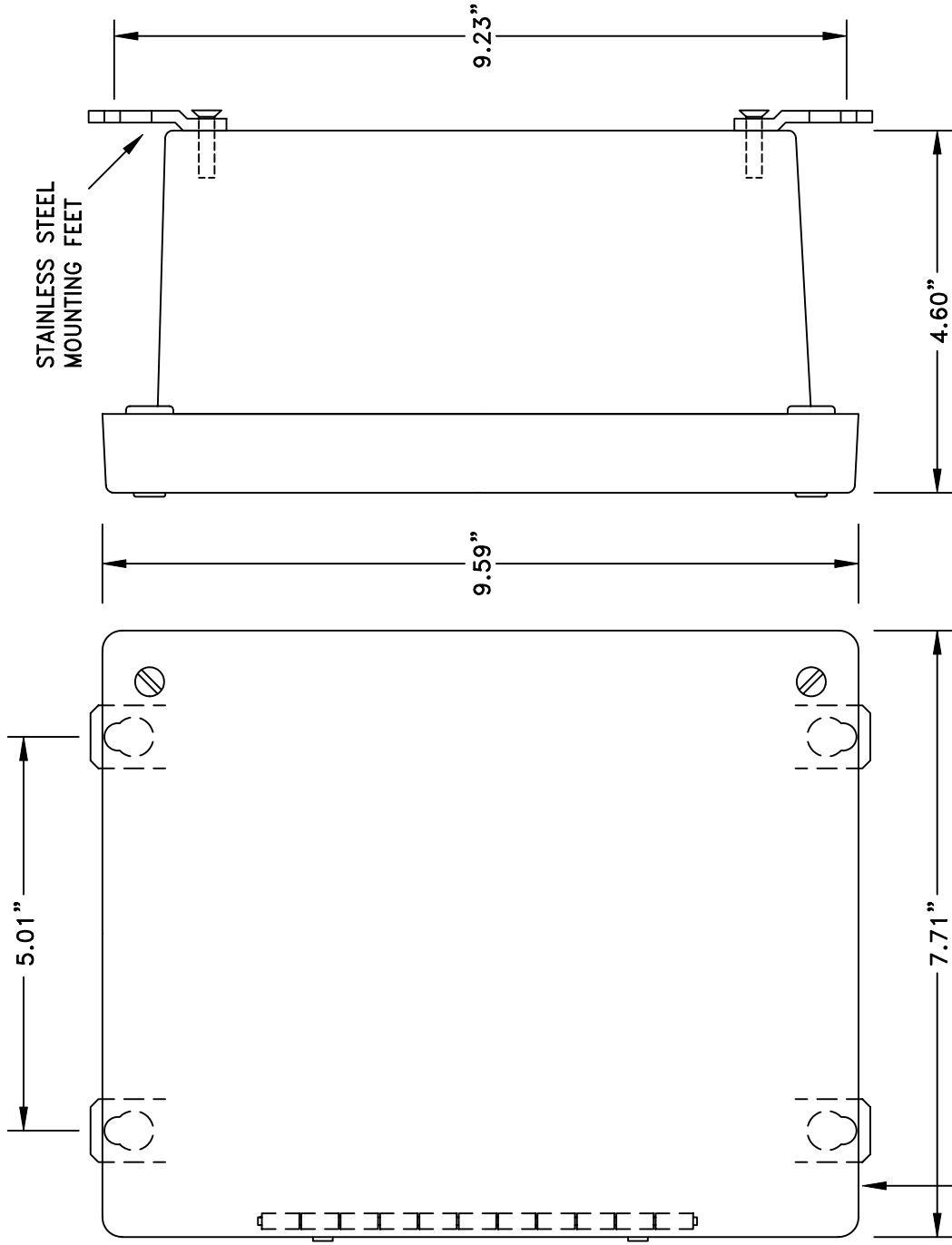

FRONT VIEW

SIDE VIEW

NEMA 4X AM SERIES FIBERGLASS ENCLOSURE
WITH STAINLESS STEEL HINGE
AND SCREW COVER

Pribusin Inc. ©			
CHKD:	DATE: OCT. 02/01	DRN: KS	
NEMA 4X AM SERIES FIBERGLASS ENCLOSURE (BOX SIZE: 8" x 6" x 4")			
DWG. NO.:	106470-2	REV. A	

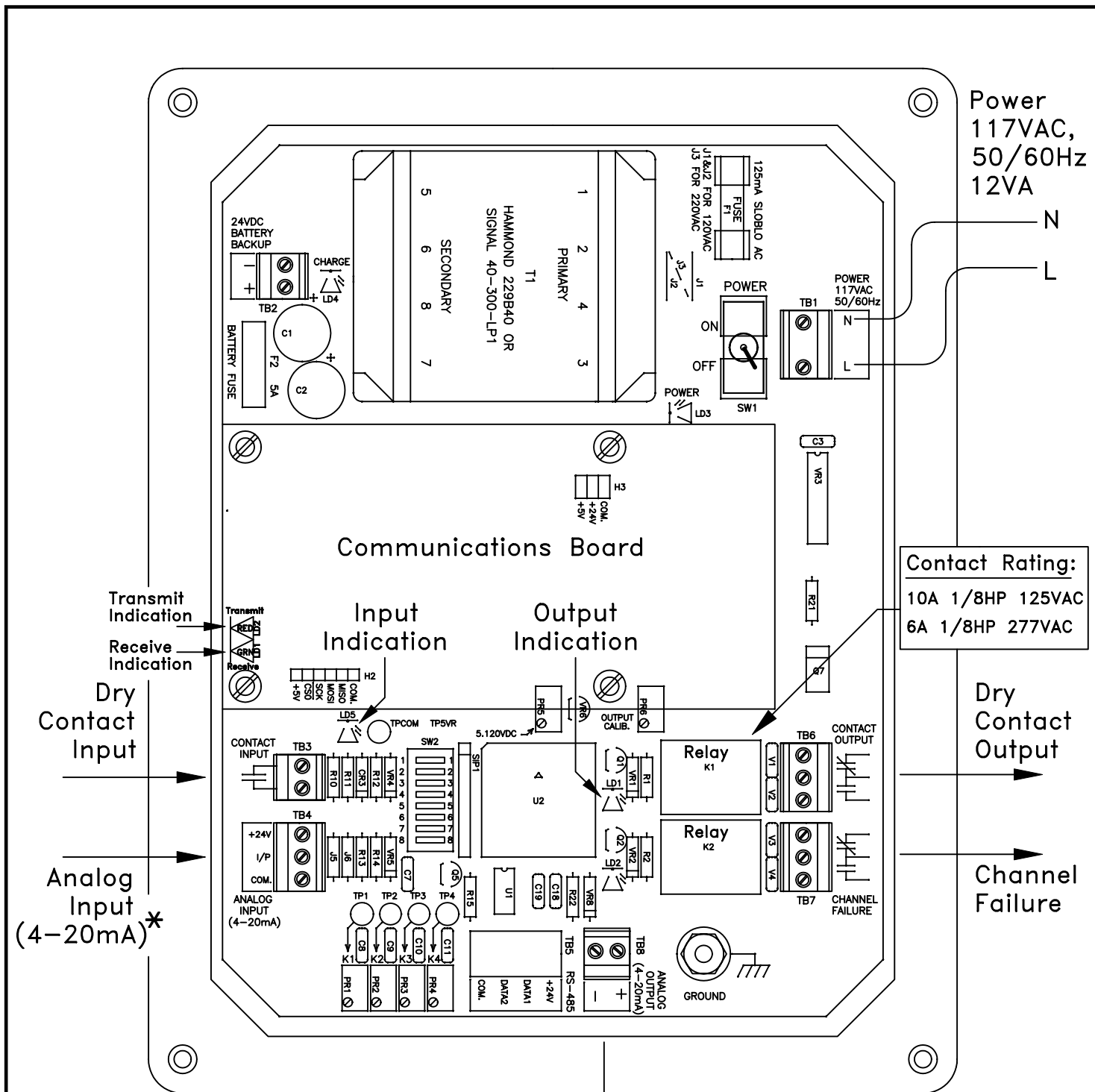

* 4-20 mA input and output ranges extend to 0 mA to 20 mA.

Analog Output (4-20mA)*

Pribusin Inc. ©		
CHKD:	DATE: Jan. 28/02	DRN: KS
Model: RCI-100-XXX Remote Control Signal Interface Panel Layout/Connections		
DWG. NO.:	106547	REV. A

RCI-100 Connections:

The RCI-100 is the main board of an RCI-100-XXX Telemetry system. It provides the input and output signal connections as well as the power supply for the unit. A separate communications board is added to the RCI-100 to allow it to communicate with other units. This communications board may have its own configuration that is in a separate section of this manual. The following configuration applies only to the RCI-100 board and is common to all communications interfaces.

AC Power & Fuse:

The RCI-100 is typically powered from 120VAC and protected by a 125mA SLOBLO fuse. It can be wired for 240VAC operation by removing (desoldering) power jumpers J1 & J2 and installing (soldering) jumper J3.

When changing the RCI-100 to 240VAC power make sure to change the fuse to half of its value, 62mA. This is important since at 240VAC the RCI-100 requires only half the current as if it were powered from 120VAC. Proper protection is only achieved by reducing the fuse value as mentioned above.

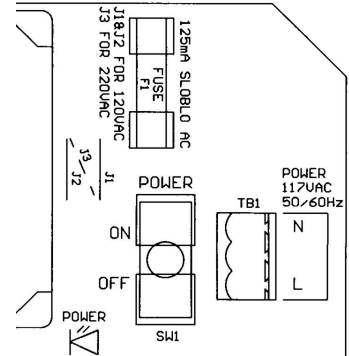

DC Power & Battery Backup:

The RCI-100 may also be powered from a 24VDC source which could be a battery or a DC power supply. The 24VDC power input is polarity protected with a fuse to prevent damage to the RCI-100 by inadvertent reverse polarity. A DC fuse provision is also provided if this power option is utilized. Insert a 5A automotive type blade fuse into the Battery Fuse socket.

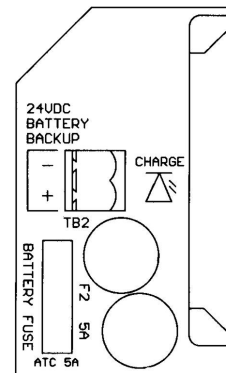

Inputs:

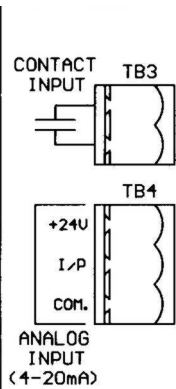

The RCI-100 has one dry contact input and one 0-20mA input. The dry contact input is excited with 24VDC and will source approximately 20mA when the contact is closed. A red LED lights up when the contact input is closed.

The analog input is configured as a 0-20mA input and has a 250Ω input impedance. The input terminal has three connections: +24V, I/P, COM. The +24V power output may be used to power field transmitters. Up to 500mA may be used to power a transmitter. The input signal is connected to I/P(+) and COM(-).

The analog input is connected to the RCI-800 in two fashions: 1) Normal (3-wire connection) or 2) two-wire connection. On a 3-wire connected input, an external power supply or the +24V power output terminal of the RCI provides power to the field transmitter. The field transmitter has a current source that provides the 4-20mA signal back to the RCI-100. If using the power supply of the RCI-100, the field transmitter may draw up to 125mA.

On a 2-wire connected input, the field transmitter receives power from the RCI-100 and superimposes the signal onto the power return path. A maximum of 20mA will flow in such a connection. Make sure to consult the field transmitter manual to determine how to connect it to the RCI-100.

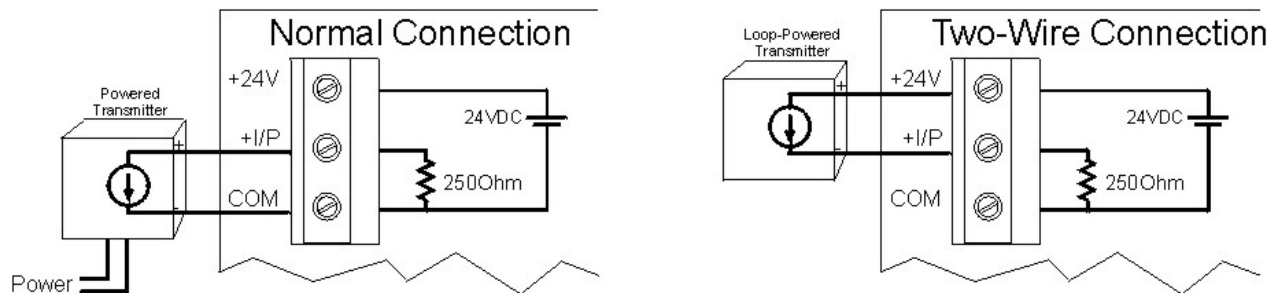

Outputs:

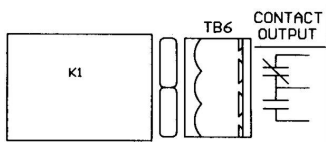

The RCI-100 has one form 'C' relay contact output and one 0-20mA analog output. The relay contact is capable of switching 120VAC, 10A or 240VAC, 6A. An energy absorbing varistor is installed across each contact to limit switching transients. A second relay contact acts as a communications fail indicator. If no communication occurred within 30 seconds, this relay contact will energize. Upon re-established communication this relay will de-energize again.

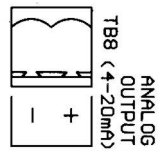

The analog output is typically configured as a 0-20mA output and can drive into a 1000Ω load, provided that the power supply to the unit is not below 24VDC. The output is not isolated from the input. Care must be taken when connecting the output to different devices so that no inadvertent ground loops are established.

Output Calibration & Input Testing:

The output on the RCI-100 is factory calibrated and should not require any adjustments. To check the calibration of the output and relays use switch SW2-7 & SW2-8 as shown below to set them to known states. If an output should require some adjustment, close SW2-8 only and turn the OUTPUT CALIB. trim pot until the output reads 20mA.

SW2-7	SW2-8	Function
OPEN	OPEN	Normal Operation
OPEN	CLOSED	Outputs=20mA, Relays=Energized
CLOSED	OPEN	Outputs=0mA, Relays=De-energized
CLOSED	CLOSED	Outputs=Inputs, Relays=Contact Inputs

If both switches are CLOSED, the analog and contact inputs are passed straight through to the analog and relay outputs. This may help in troubleshooting input and output signals.

Make sure both switches are OPEN before resuming normal operation.

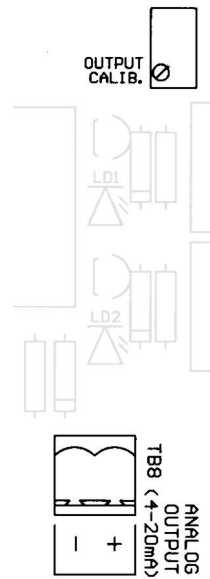

RCI-100 Configuration:

The RCI-100 requires no configuration other than for its communication fail operation. In the event of a communications failure on the communications board, the RCI-100 can be set up to take various actions on its outputs. This may be desirable in order to place connected devices into a safe operating mode. By default factory setting, all outputs remain at their last known state if a communications failure occurs.

SW2-	Function	OUT	IN
1	Relay Fail Mode	No Change	See SW2-2
2	Relay Fail Status	De-Energize	Energize
3	Output Fail Mode	No Change	Ramp to K1*
4			
5			
6			
7	I/O Calibration		
8	I/O Calibration		

- * If SW2-3=CLOSED then the analog output will ramp to the setting of K1. The output will change at a rate determined by the setting of K2. The settings of the trim pots can be read on test points TP_{1,2} using a voltmeter. The test points read a voltage of 0-5V for a 0-100% adjustment.

$$TP_1 = \frac{Output}{20} \times 5Volt$$

$$TP_2 = \frac{RampRate}{60} \times 5Volt$$

where, *Output* = 0-20 (mA) and *Ramp Rate* = 0-60 (seconds) (5 sec. minimum)

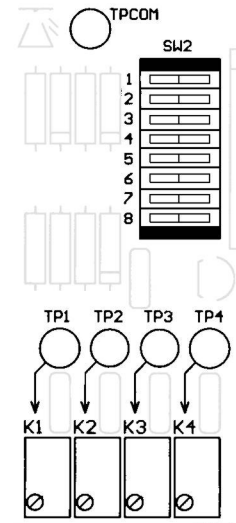

RF9 Communication Option:

The –RF9 communications option to the RCI series utilizes license-free 902-928 MHz spread spectrum radio frequency transmissions to exchange the signal data between a host and its remote(s). There are two types of **Topologies** that can be configured: 1) Point-to-Point and 2) Host-to-Multipoint.

In a **Point-to-Point** topology one host communicates with one remote. The two exchange all their signals with one another. The remote is configured as remote #1 even though it is the only remote in the system.

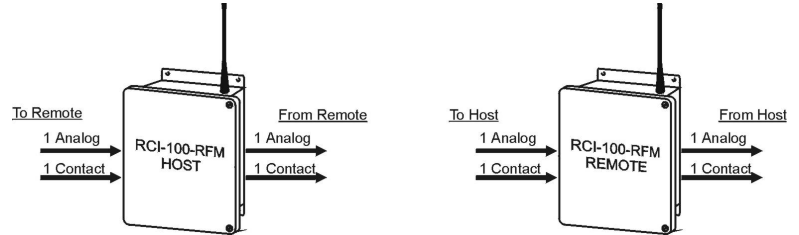

In a **Host-to-Multipoint** topology one host communicates to several remotes. Each remote is assigned an address (1,2,3, etc.) so that the host may distinguish between them. There may at most be as many remotes as there are inputs & outputs on the host.

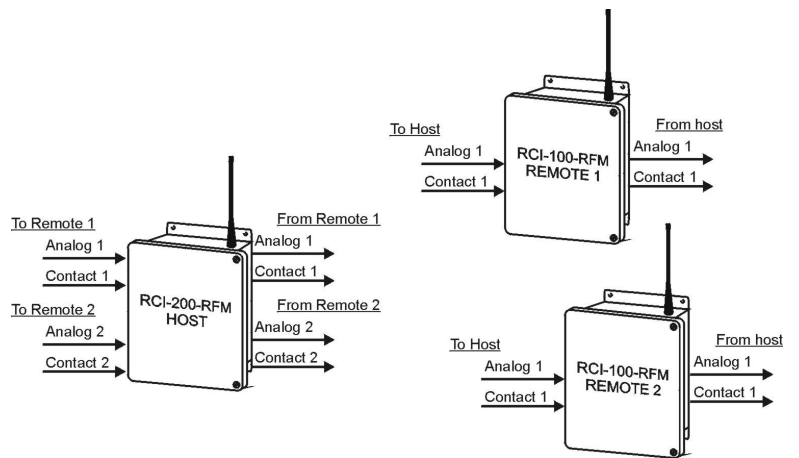

For example, an RCI-200, having two analog/contact inputs and outputs, may communicate with up to two RCI-100 remotes each having one analog/contact input and output. In this case all **#1 inputs and outputs on the host correspond to the #1 inputs and outputs on remote #1** and all **#2 inputs and outputs on the host correspond to the #1 inputs and outputs on remote #2**. The second analog/contact input and output on each of the two remotes would be unused.

A **Network ID** allows multiple RFM systems to co-exist within close proximity without interfering with one another. There are four Network ID's to choose from: A, B, C or D. The host and its remote(s) must be set to the same Network ID in order for them to communicate with each other.

All radio configurations are done via two banks of DIPswitches. SW1 assigns the remote address from 1 to 100 using a binary encoding scheme. SW2 assigns the Topology, Network ID, Channel Numbers and Host/Remote Mode. The switches are located on the communications board just below the radio. They are a slanted rocker type that flips **up for OFF** and **down for ON**.

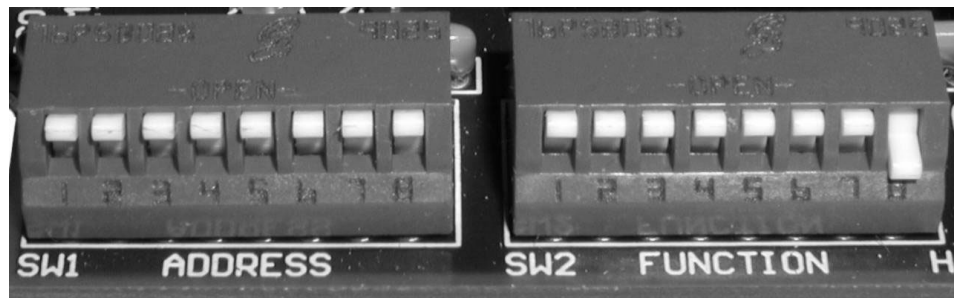

Radio Configuration:

The radio communication board has two banks of 8-position DIPswitches: SW1 and SW2. The function of these switches is slightly different for a host unit and a remote unit.

SW1-	HOST	REMOTE
1	# of Remotes	Remote Address
2	# of Remotes	Remote Address
3	# of Remotes	Remote Address
4		
5		
6		
7		
8		

SW2-	HOST	REMOTE
1	# of Channels on each Remote	# of Channels on this Remote
2	# of Channels on each Remote	# of Channels on this Remote
3	# of Channels on Host	
4	# of Channels on Host	
5	Network ID	Network ID
6	Network ID	Network ID
7	RF Output Power	RF Output Power
8	Host / Remote Select	Host / Remote Select

Network ID:

The Network ID is common to both the host and remote modes of operation. All hosts and remotes that are intended to communicate with each other must be set to the same Network ID. Four ID's are available: A, B, C, D. They are set as shown in the table.

SW2-5	SW2-6	Network ID
UP	UP	A
DOWN	UP	B
UP	DOWN	C
DOWN	DOWN	D

RF Output Power:

The radio output power can be selected with SW2-7. For shorter transmission ranges select the 100mW range to limit the amount of 'RF pollution'. Select the 1W setting for: a) longer transmission ranges, b) heavy foliage transmission scenarios, c) if there is no communication at the 100mW setting, or d) if the signal strength is less than -93dBm.

SW2-7	RF Power
UP	100 mW
DOWN	1 W

Host Configuration:

To make an RCI-100 operate as a host unit, make sure that SW2-8 is flipped down.

Next, set the **number of remotes** that the host is to communicate with using SW1-1, -2, -3. These switches are binary encoded as shown in the chart to the right.

SW1-1	SW1-2	SW1-3	# of Remotes
UP	UP	UP	1

Next, set the **number of channels of each remote** using SW2-1, -2. One channel is considered 1 analog input/output plus 1 contact input/output. Hence an RCI-100 can have at most 1 channel.

SW2-1	SW2-2	Channels on Remotes
UP	UP	1

Next, set the **number of channels of the host** using SW2-3, -4. An RCI-100 can at most have 1 channel. This is the number of channels that will be exchanged between the host and each remote.

SW2-3	SW2-4	Channels on Host
UP	UP	1

Remote Configuration:

To make an RCI-100 operate as a REMOTE unit, make sure that SW2-8 is flipped up.

Next, set the **remote address** using SW1-1, -2 & -3. Each remote in a system must have a unique address.

SW1-1	SW1-2	SW1-3	Remote Address
UP	UP	UP	1
DOWN	UP	UP	2
UP	DOWN	UP	3
DOWN	DOWN	UP	4
UP	UP	DOWN	5
DOWN	UP	DOWN	6
UP	DOWN	DOWN	7
DOWN	DOWN	DOWN	8

Next, set the **number of channels on this remote** using SW2-1, -2. One channel is considered 1 analog input/output plus 1 contact input/output. Hence an RCI-100 can have at most 1 channel.

SW2-1	SW2-2	Channels on Remote
UP	UP	1

Received Signal Strength Indicator (RSSI):

The radio communications board has a signal strength indicator to show the level of the signal that was received from another radio. The indicator consists of 3 LED's labeled 1, 2 & 3. It is desirable to operate with the highest signal strength achievable. If the signal strength is less than -93 dBm, it is advisable to try to make adjustments to then system to bring the signal strength up. A higher power setting on the radio or a higher gain antenna can be used to increase signal strength and achieve more reliable operation of the radio system.



Signal Strength (dBm)	LED 1	LED 2	LED 3
-108	Flashing	Off	Off
-101	On	Off	Off
-93	On	Flashing	Off
-86	On	On	Off
-79	On	On	Flashing
-71	On	On	On

Cable & Antenna Selection & Installation:

The antenna is a very important component in a radio system. Make sure you consult the factory for proper antenna selection for your project. Cable leading from the radio to the antenna is just as important in establishing a reliable link. Special low-loss cable is available to ensure minimal signal losses in the cable leading to the antenna. This cable must be kept as short as possible. We recommend purchasing the cable from Pribusin Inc. to ensure a good match for the entire system. **Regular TV coaxial cable or even satellite dish coaxial cable will not work.** Even 'good' TV cables have enormous losses at the high frequency of this radio.

Line-of-Sight Installation:

To achieve maximum operational reliability, all antennas in a system must be installed in a line-of-sight fashion. This means that there are no obstructions between the host antenna and each of the remote antennas. This may require the antenna to be raised on a mast with some low-loss coaxial cable being installed. We recommend coaxial cables be kept as short as possible and not exceed 100ft.

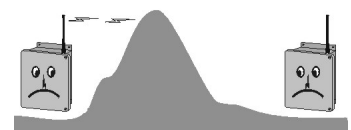

In some cases a direct line-of-sight may not be established, but if there are solid structures such as buildings, tanks etc. in the vicinity, the signal may reflect off these surfaces and reach an antenna via an indirect path. Such installations are not easy and are difficult to predict without on-site testing.

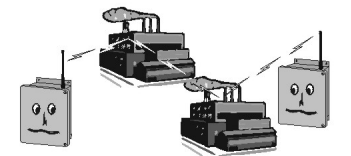

Antenna Polarization:

When installing antennas keep in mind that polarity matters. Align all antennas in the same direction. For example, if using omni-directional antennas, point them all straight up (or straight down). Do not point them in different directions or the range of the antennas will be greatly diminished to the point where no transmission may take place.

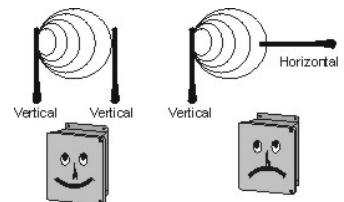

We suggest you consult Pribusin Inc. or your local Sales Rep. to discuss your antenna and cable requirements.